

WATER MANAGEMENT 2023





Claude FAIVRE, founder of the company in 1958

Faivre is a french company, and one of the world leaders in the conception, manufacture and production of aquaculture machines. We are employing more than 40 persons. Since 1958, thanks to our knowledge of the market and our strong experience in aquaculture, Faivre company has developed high quality products to satisfy all of your needs, from one product to the full installation. Strength, effectiveness and simplicity are the qualities of our productions !

Let us realize your projects !

Since 1958, Faivre story is ongoing.

Summary

DRUM FILTER

Description	5
System	6
Technical	7
Applications	8
Smart Filter	10
SpiderPlate	12
Models Filter/Aerator	14
Filter 40	16
Filter 60	24
Filter 80	32
Filter 120	40
Filter 160	48
Filter 200	56

AERATOR

Flobull	65
Aquasub	68



FAIVRE

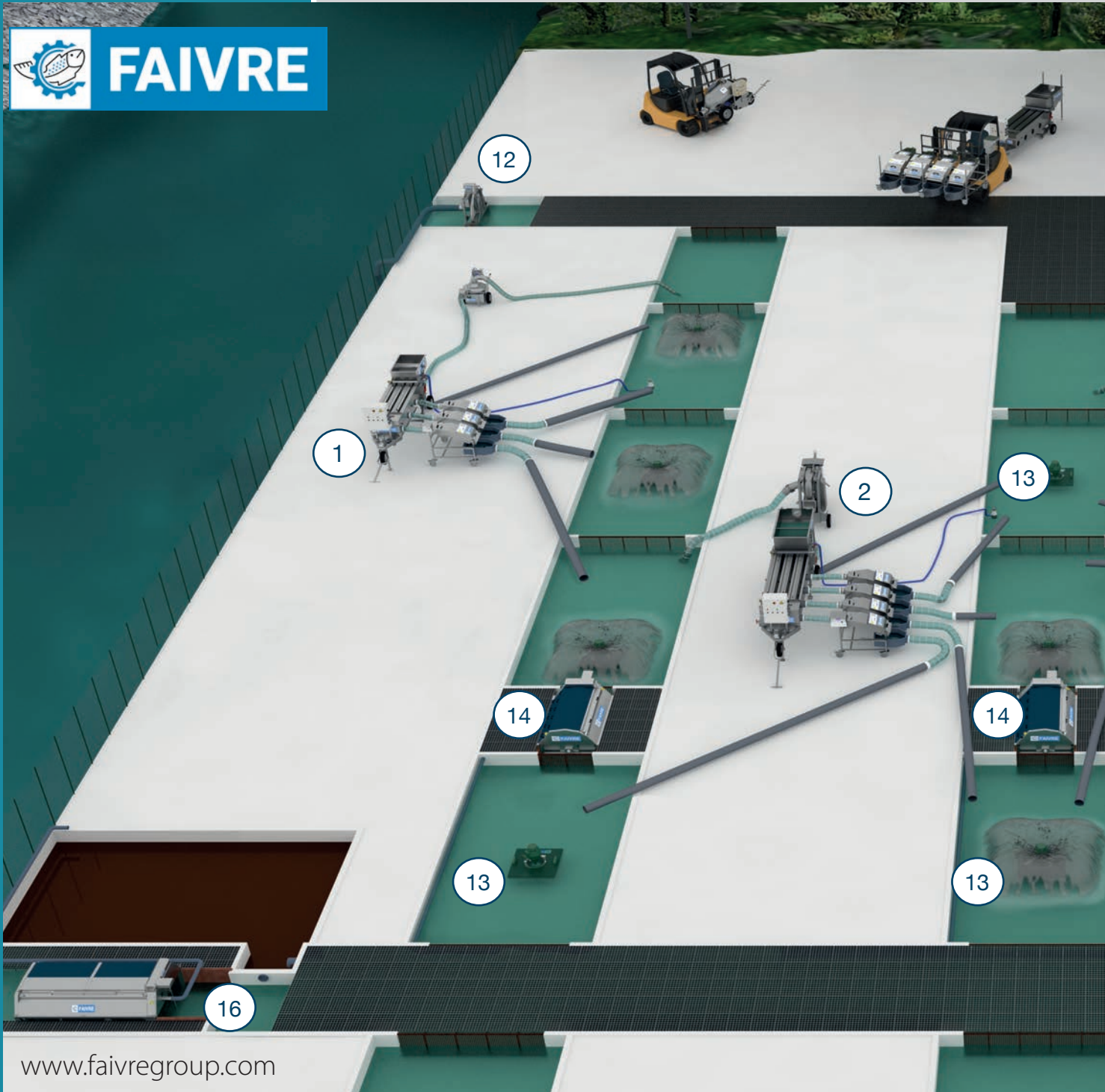

www.faivregroup.com

Catalogue / Catalog
Live stock management
Gestion de production

9

Harvesting Transfert pack 50
Pack chargement gros poissons
Pour poissons / for fish :100g-3,5kg
Ref.pump : **PV0801**
Ref. dewatering : **TD0801**

1

Grow out Standart pack 30
Pack tri base grossissement
Pour poissons / for fish : 40g-700g
3 sizes/3 tailles
2-3 tonnes/hour
Ref. : **GPST3**

10

Grow out Transfert pack 40
Pack chargement rapide
Pour poissons / for fish :100g-1,5kg
Ref.pump : **PH0803**
Ref. dewatering : **TD0801**

2

Grow out Standart pack 40
Pack tri ultra grossissement
Pour poissons / for fish : 40g-1,5kg
4 sizes/4 tailles
3-4 tonnes/hour
Ref. : **GPST4**

11

Counting station
Station de comptage
Pour poissons / for fish 5g à 4,5kg
Ref. : **PESCATROL**

3

Grow out High Capacity pack 40
Pack tri super rapide grossissement
Pour poissons / for fish : 40g-1,5kg
4 sizes/4 tailles
4-6 tonnes/hour
Ref. : **GPHC4**

4

Harvesting High Capacity pack 60
Pack tri récolte pour gros poissons
Pour poissons / for fish : 400g-3,5kg
3 sizes/3 tailles
4-6 tonnes/hour
Ref. : **HPHC6**

Catalogue / Catalog
Water management
Traitement de l'eau

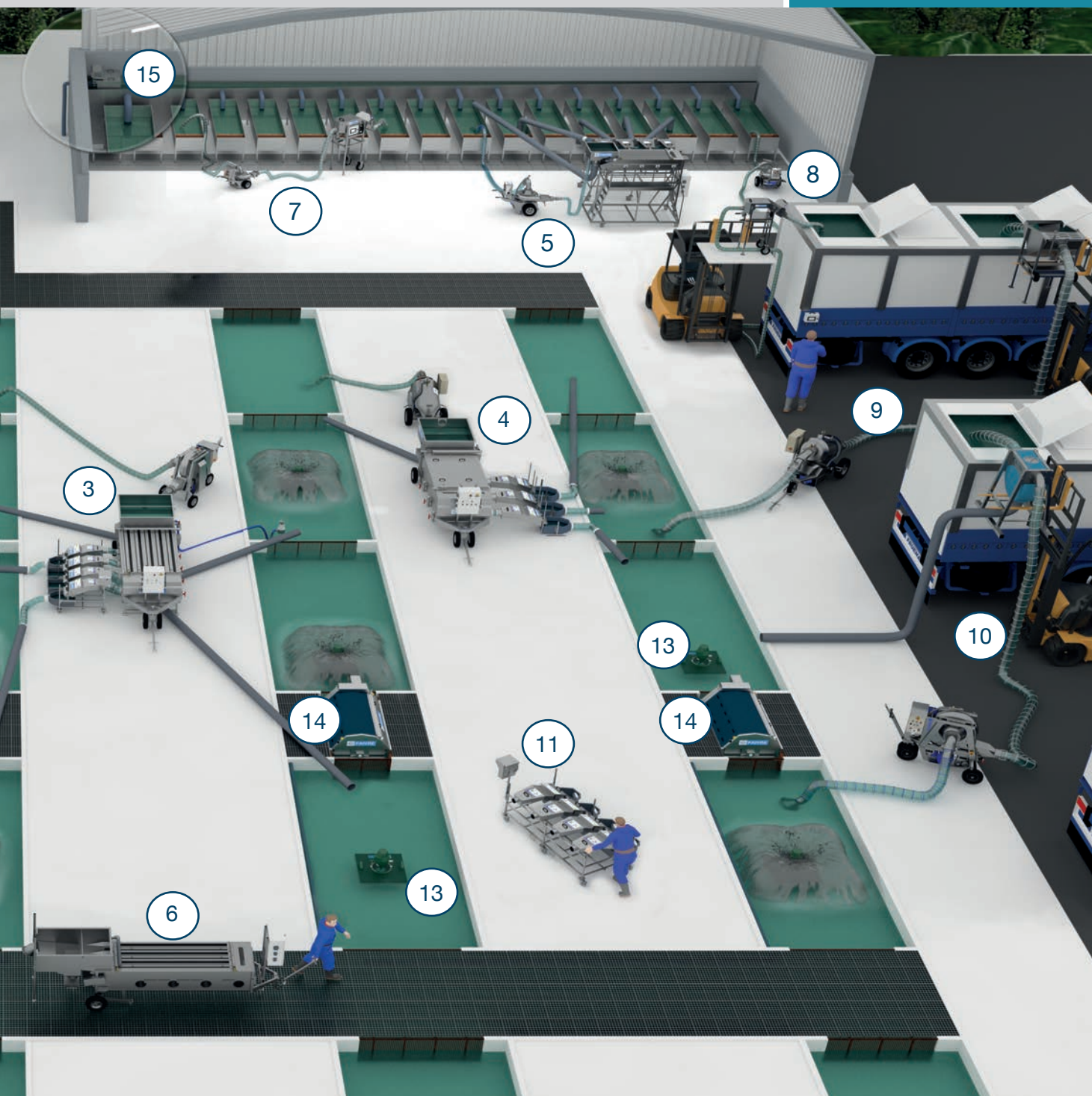

5

Hatchery Standart Pack 10
Pack tri pour alevinage
Pour poissons / for fish : 40g-1,5kg
4 sizes/4 tailles
3-4 tonnes/hour
Ref. : **NPST1**

6

Helios 40 grader
Trieur Helios 40
Pour poissons / for fish : 5g-1,5kg
4 sizes/4 tailles
3-5 tonnes/hour
Ref. : **TH4436**

7

Hatchery transfert pack 10
Pack transfert alevinage
Pour poissons / for fish : 0,2g-20g
Ref. : **NPTL1**

8

Hatchery transfert pack 10
Pack chargement alevinage
Pour poissons / for fish : 0,2g-20g
Ref. : **NPTL1**

13

Flobull aerators 0,75kw
Aérateur Flobull 0,75kw
Ref. : **APF0101** (page 69)

14

Drum filter 24-160 with frame
Filtre à tambour 24-160 sur bati
Mesh / maille 63µ
Ref. : **FT16024B6A** (page 56-57)

15

Drum filter 2-60 on tank
Filtre à tambour 2-60 avec réservoir
Mesh / maille 36µ
Ref. : **FT06002B6A** (page 32-33)

16

Drum filter 40-200 with frame
Filtre à tambour 40-200 sur bati
Mesh / maille 80µ
Ref. : **FT20040B6A** (page 60-61)



FAIVRE

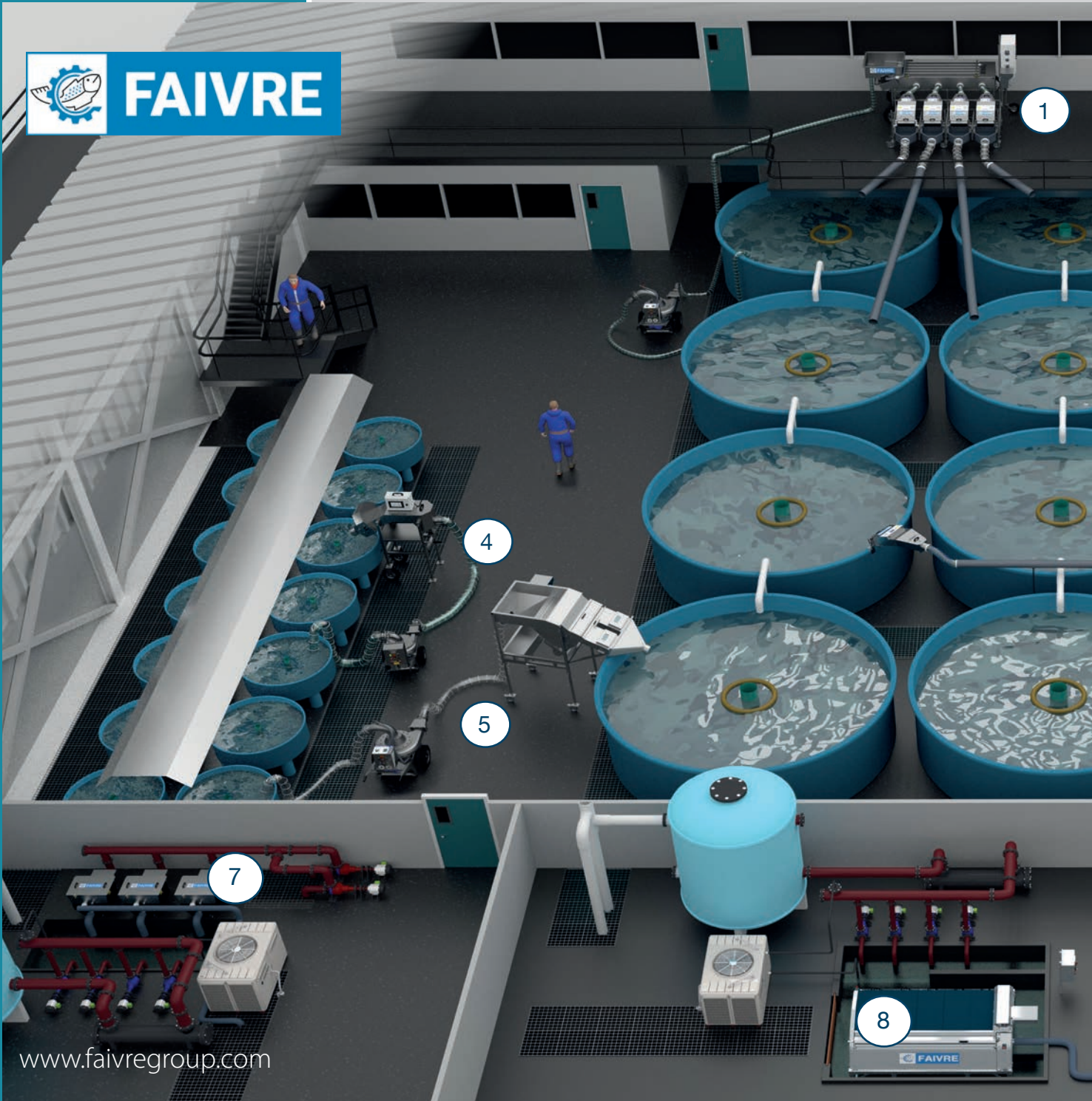

www.faivregroup.com

Catalogue / Catalog
Live stock management
Gestion de production

Catalogue / Catalog
Water management
Traitement de l'eau

1

Hatchery Standart Pack 10
Pack tri pour alevinage
Pour poissons / for fish : 1g-150g
4 sizes/4 tailles
3-4 tonnes/hour
Ref. : **NPST1**

2

Grow out standart pack 30
Pack tri base grossissement
Pour poissons / for fish : 40g-700g
3 sizes/3 tailles
2-3 tonnes/hour
Ref. : **GPST3**

3

Grow out standart pack 40
Pack tri rapide grossissement
Pour poissons / for fish : 40g-1,5kg
4 sizes/4 tailles
3-4 tonnes/hour
Ref. : **GPST4**

7

Drum filter 2-60 on tank
Filtre à tambour 2-60 avec réservoir
Mesh / maille 36µ
Ref. : **FT06002C4A** (page 32-33)

8

Drum filter 24-160 with frame
Filtre à tambour 24-160 sur bati
Mesh / maille 63µ
Ref. : **FT16024B4A** (page 56-57)

9

Drum filter 40-200 with frame
Filtre à tambour 40-200 sur bati
Mesh / maille 80µ
Ref. : **FTB20040B4A** (page 60-64)

nt working in a RAS farm



4

Transfer & counting pack
Pack transfert comptage
Pour poissons / for fish : 0,2g-20g
Ref : **NPTL1**

5

Transfer & counting pack
Pack transfert comptage
Pour poissons / for fish : 40g-700g
7-9 tonnes/hour
Ref : **GPTL3**

6

Fish Pump Pescavac 50
Pack chargement gros poissons
Pour poissons / for fish :100g-3,5kg
ref : **PV0801**

DRUM FILTER

- Description..... 9
- System..... 10
- Technical..... 11
- Applications..... 12
- Smart Filter..... 14
- Spiderplate..... 16



Description

DRUM FILTER

The filters are designed with a rugged stainless steel structure: The main subassemblies are described below :

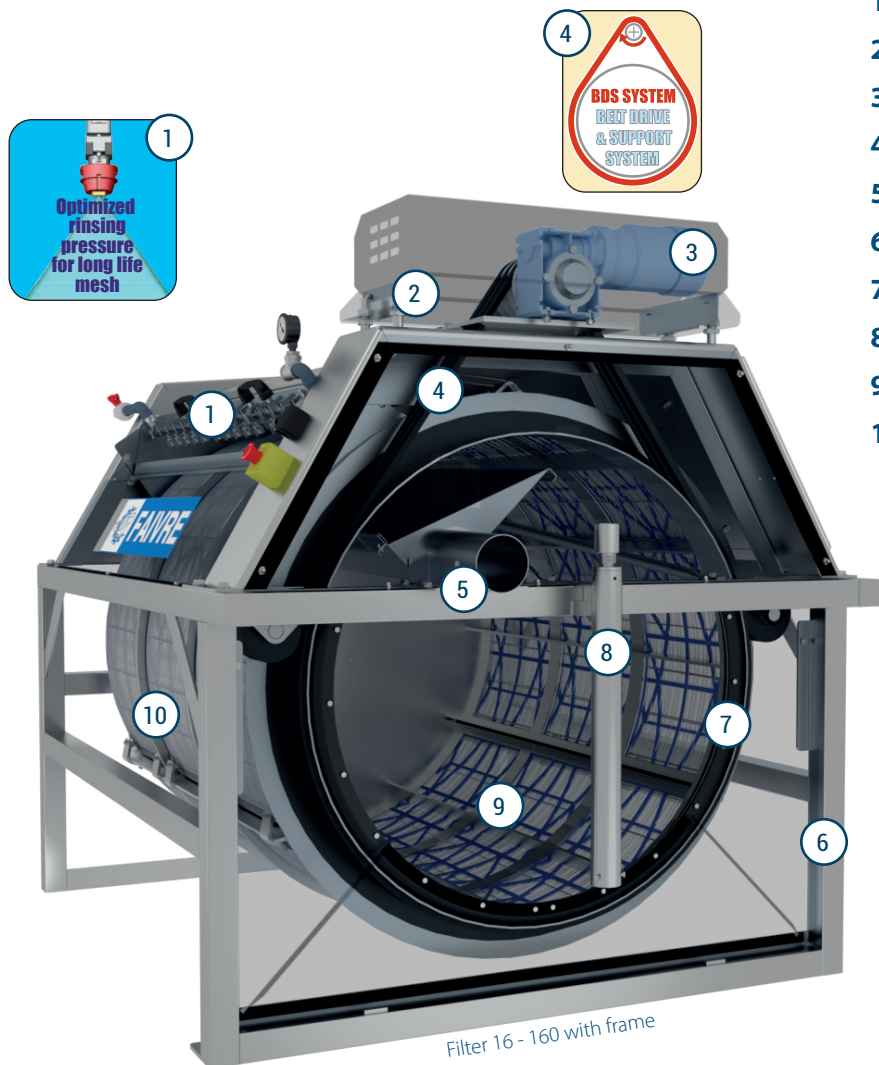

- 1 - Reversible rinsing ramp.
- 2 - Drive motor support.
- 3 - IP55 Gearmotor.
- 4 - BDS system (Belt Drive System).
- 5 - Stainless steel sludge evacuation pipe.
- 6 - Stainless steel frame
- 7 - Water tightness rubber seal.
- 8 - Level probe
- 9 - Filtration mesh « Spiderplates[®]»
- 10 - Stainless steel drum

● 3 models of filters offered



● Filter with tank



● Filter with frame



● Filter with input by pipe

Filters with tanks and pipe inlets are equipped with an internal safety overflow (weir)

www.favregroup.com

Pictures and technical data are not contractual. FAIVRE Sasu can bring to its equipments any modifications required, at any time.

● Operating system of the automatic drum cleaning filter

● Principle

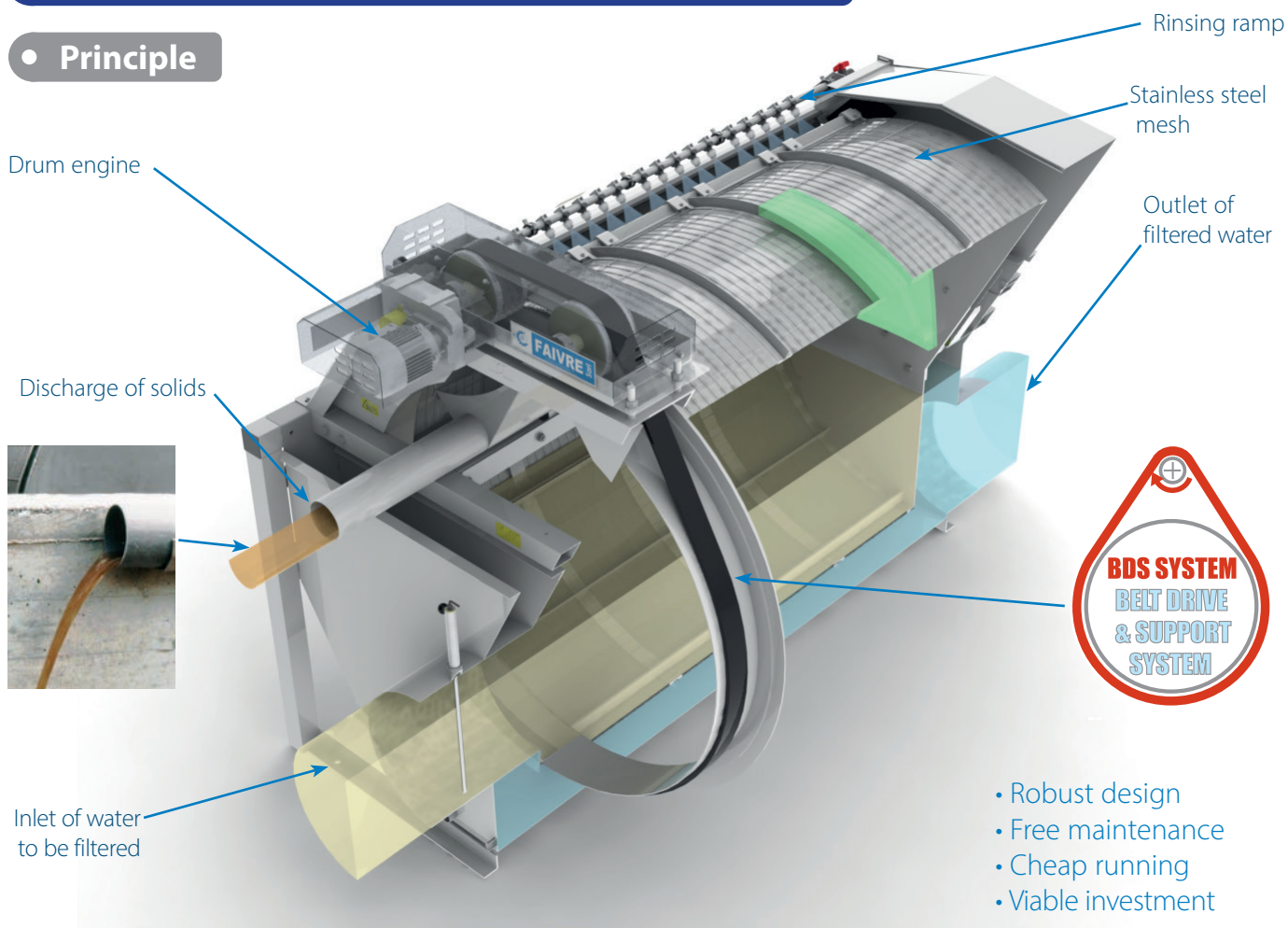

The operating system is pretty simple : water to be filtered is directed into a rotating drum. The outer surface of the drum is constructed with a number of stainless steel frames covered with stainless steel mesh. Suspended solids larger than the perforations unable to pass through the mesh are retained in the drum.

● Simplicity

The slowly rotating drum (3 to 8 rpm, depending on the model) separates the solids from the water and discharges the solids through a discharge hopper located at the left of the drum as indicated on sketch.

● Reliability

FAIVRE filters are designed to resist all corrosion, due to their construction entirely of stainless steel AISI 304L for fresh water, and AISI 316L for salt water all parts of the filter have been engineered and calibrated for their specific duty (duplex stainless for special use).

FAIVRE drum filters are constructed with minimum of moving parts and are belt driven (BDS System).

● Robustness

Maintenance is reduced to a minimum. The efficiency of the design is contained within the construction of the stainless filter plates which are integrated into a strong stainless steel framework. Replacement of filter plates is possible in a few minutes due to the exclusive design. The filter plates are easy to clean and to replace on the drum unit.

FAIVRE offers a complete range of working filters which are strongly made and economic to operate

● **The highest reliability for the lowest operating cost**



Despite the extreme strength of their frame and drum, other technical features make the difference between a Faivre drum-type filter and any other make even greater.

Since 1996, our only concern has been to build the most reliable, efficient drum filter on the market. As customers around the world can bear witness, our filters are more than able to run for several years, 24 hours a day, with lower maintenance requirements, in fresh water and sea water alike !!

JUST IMAGINE HOW MUCH MONEY YOU WILL SAVE USING OUR FILTERS.

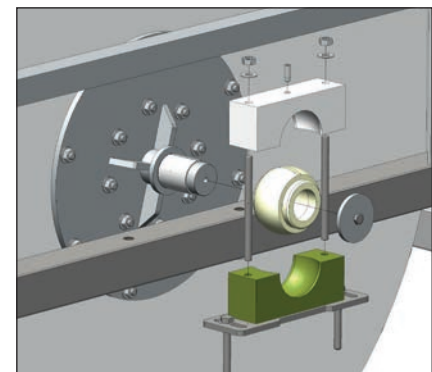
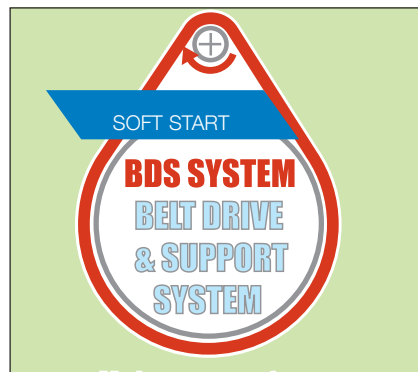
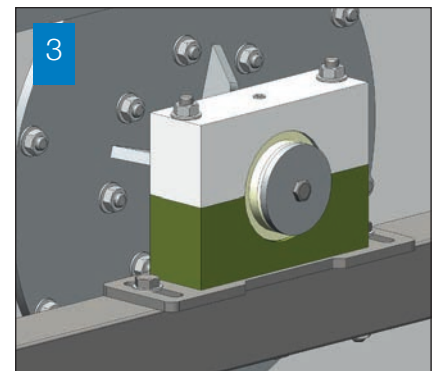
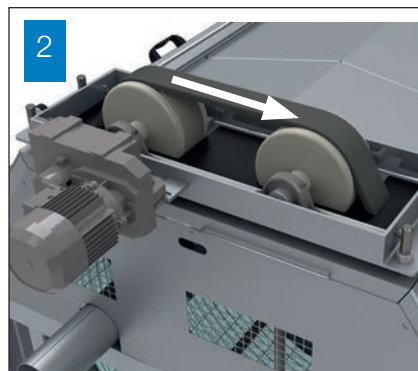
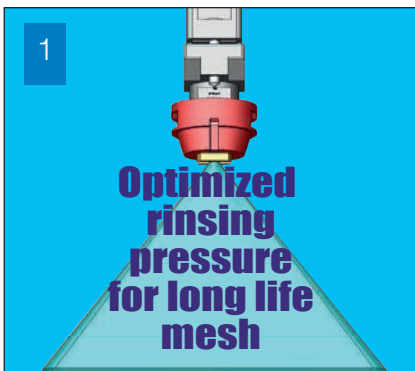

● Robustness with stainless Steel mesh

● Flexibility, simplicity and less energy with a belt

● Reliability with a strong design

1- First of all an exclusive plate system entirely in stainless steel. The bonded fabric stretched on stainless steel supports is able to last several years !! in both fresh and sea water ! *

2- Our system of driving the drum by POLY-V belt, it has demonstrated how efficient and how free maintenance it is. With a belt start and stop are soft

3- NOTHING is left to chance, the back bearing on drums was designed in our design department. We could not find a bearing strong enough and resistant to corrosion, so we decided to build one. And the result is all we'd hoped for, the swivel bearing is self-lubricating.



★ Stainless steel mesh ★



* Polyester mesh available.

* Depend on water temperature and salinity sea water.

● Fish farm outlet/inlet

The filtration mesh can vary from 80 to 100 microns for this serie. High water through puts often require the use of a model 160. Official bodies concerned with the quality of discharges from fish farming.

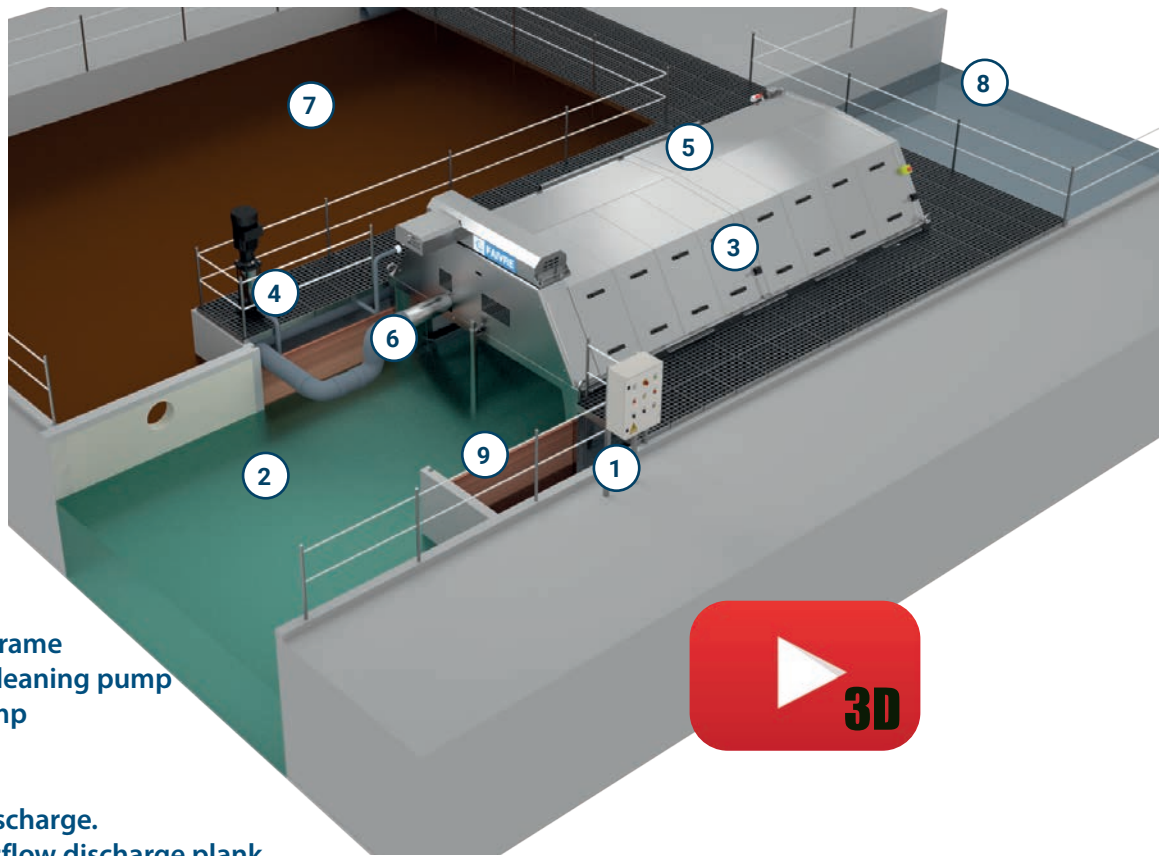

Above :

- 1 - Control unit
- 2 - Entry channel
- 3 - Drumfilter with frame
- 4 - Water pressure cleaning pump
- 5 - Drum rinsing ramp
- 6 - Sludge outlet
- 7 - Setting tank
- 8 - Filtered water discharge.
- 9 - Bypass with overflow discharge plank

● Recirculation system

For 15 years the drum-type filter has been used in closed circuit. In this configuration the mesh can vary from 26 to 63 microns, but the 36 micron mesh is most often used as it offers a good compromise. The drum-type filter has

enabled the construction of an efficient closed circuit, because of its compact size and its efficiency.

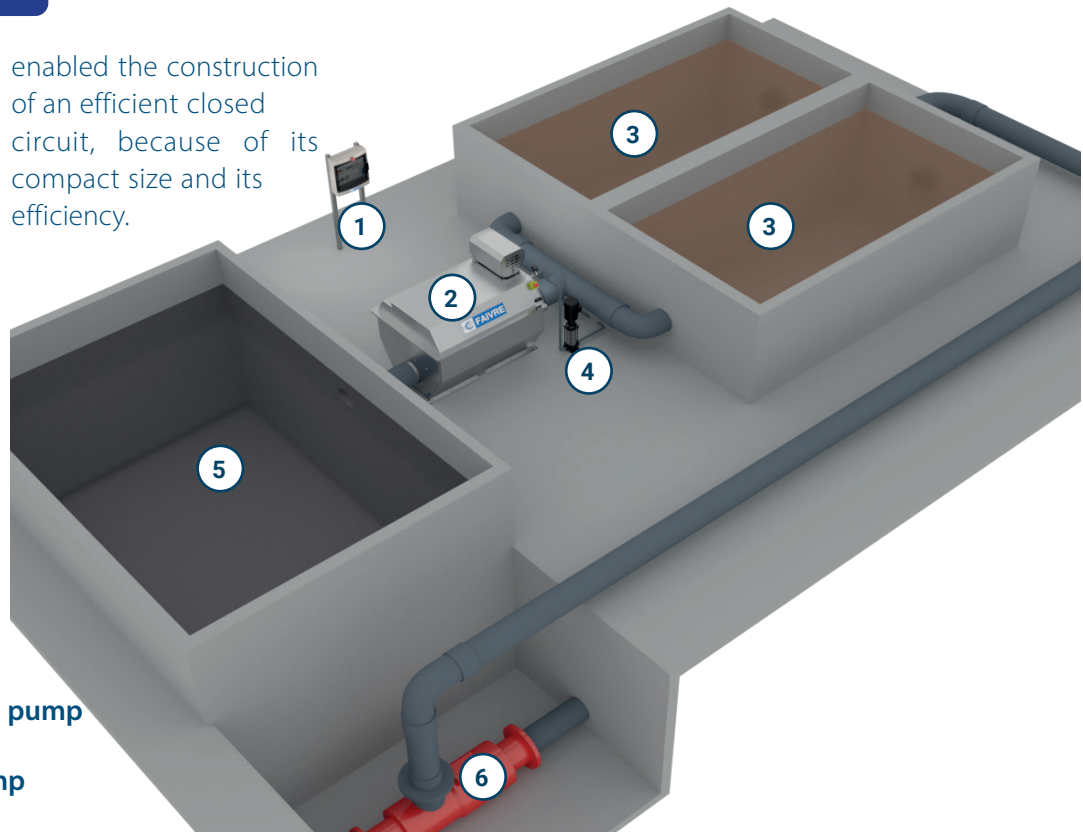

Above :

- 1 - Control unit
- 2 - Drum filter on tank
- 3 - Raceways
- 4 - Water pressure cleaning pump
- 5 - Biofilter
- 6 - Recirculation Water pump

● Outlet fish farm



● Inlet fish farm



● Recirculation system



Smart Filter

AN INNOVATIVE AND HIGH-PERFORMANCE TECHNOLOGY

For over 20 years, the drum filter ROTOCLEAN has become one of the best filters for waste water treatment . ROTOCLEAN, the robust and autocleaning machine, has been made to filter every effluent. With more than 2000 filters sold all around the world, FAIVRE Group has developed 210 models of drum filters.

With the international success of ROTOCLEAN, FAIVRE wanted to automatize its drum filter to reduce its maintenance. Thus was born the SMART FILTER: a new generation drum filter. As robust as ROTOCLEAN, the SMART FILTER integrates innovative technologies. Intelligence and timesaver perfectly define the SMART FILTER.

Smart filter



THANKS TO ITS NEW FUNCTIONALITIES, YOU CAN CONTINUOUSLY FOLLOW-UP YOUR SMART FILTER:

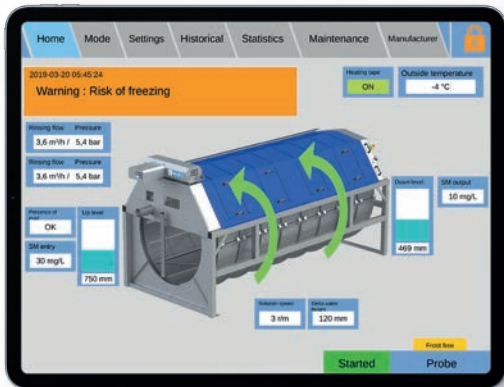

Visual representation of the "home" screen of SMART FILTER



Visual representation of the "maintenance" screen of SMART FILTER

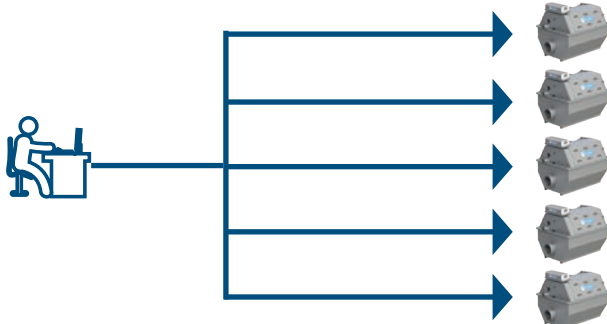

Able to control one or more filter(s) remotely

Thanks to its high-end probes, your SMART FILTER will inform you in case of any dysfunction

SMART FILTER is an economic innovation thanks to the reduction of its maintenance cost.

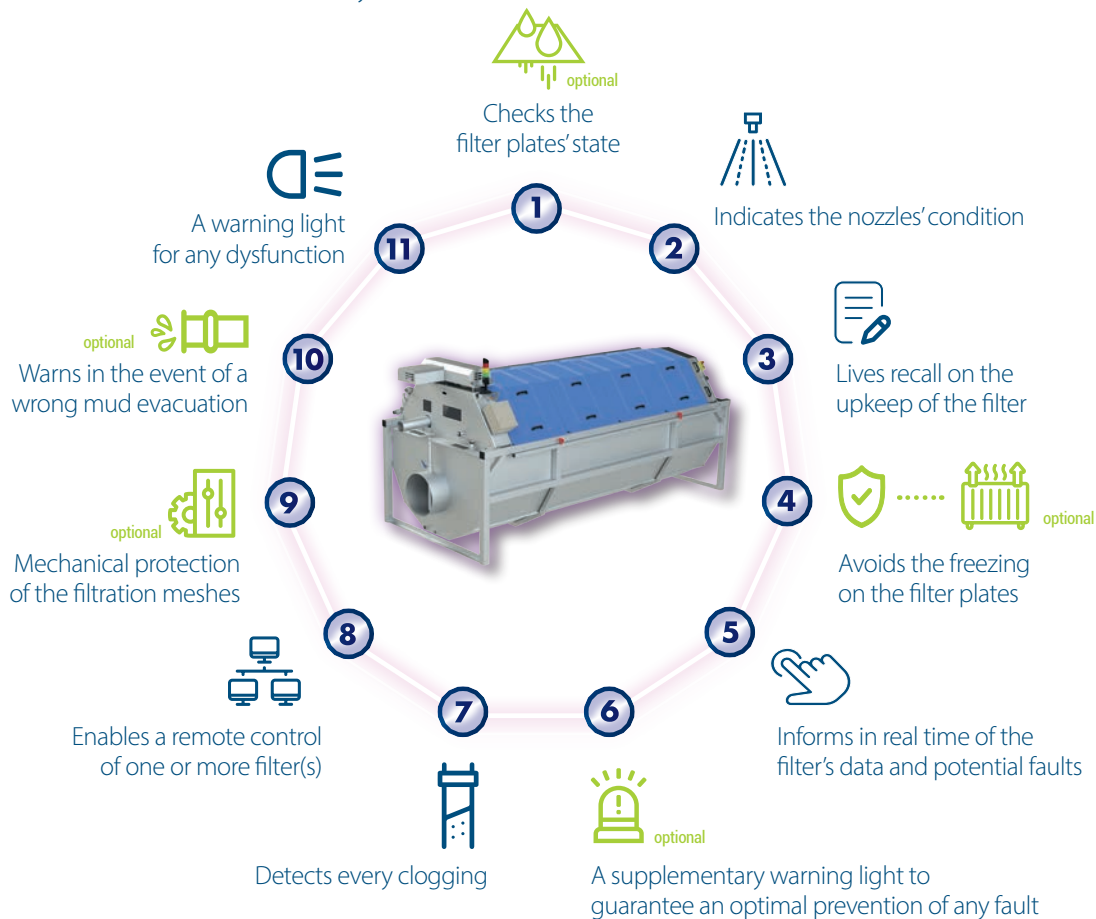

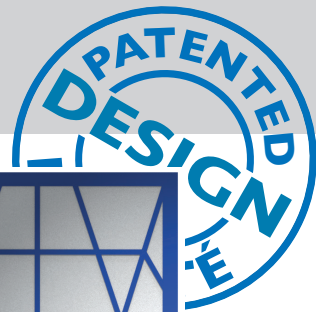

Spiderplate

After 3 years of research, the FAIVRE group is pleased to present its new patented mesh support «Spiderplate».

Inspired by nature because it resembles a spider's web with a strong optimization of the percentage of void and increased mechanical resistance.

In injected recyclable plastic, it combines the advantage of being flexible, solid and resistant to corrosion.

The design and the patented arrangement of the profiles allow it an optimal filtration surface and great resistance to pressure.

The capture of impurities is very effective thanks to its triangle profiles. The sand and the large impurities are brought up easily and remain intact without disintegrating.

The economic and ecological aspect is also very important because this new plate is less expensive to manufacture and to transport (lighter than stainless steel and transport flat in a cardbox).

This new super efficient «Spiderplate» plate is compatible with all our drum filter models 80, 120, 160 and 200. (not suitable for model 40 and 60 filters).

It is backward compatible with all filters in service for 25 years!

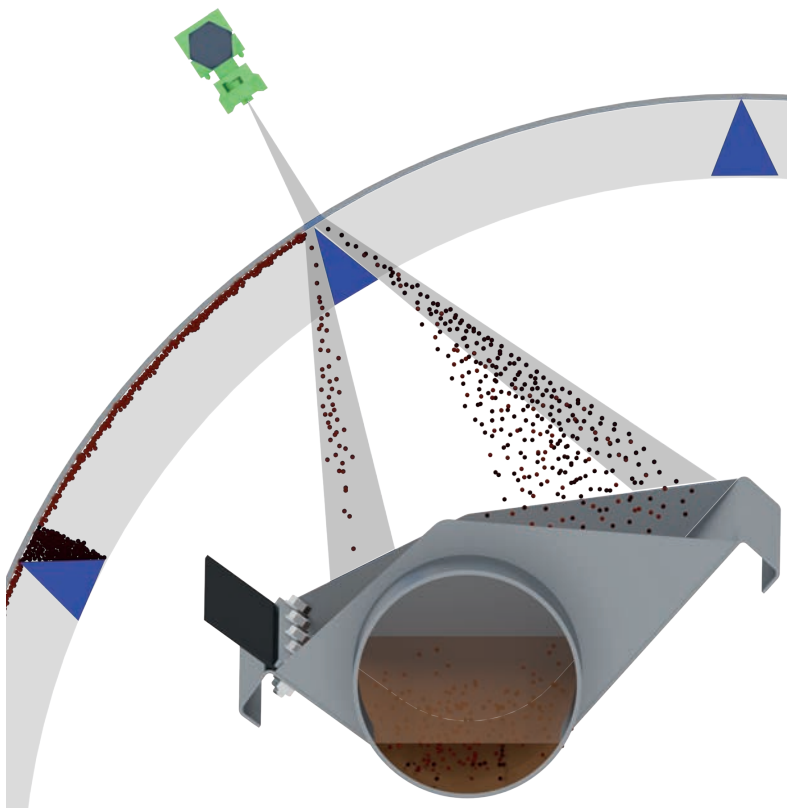
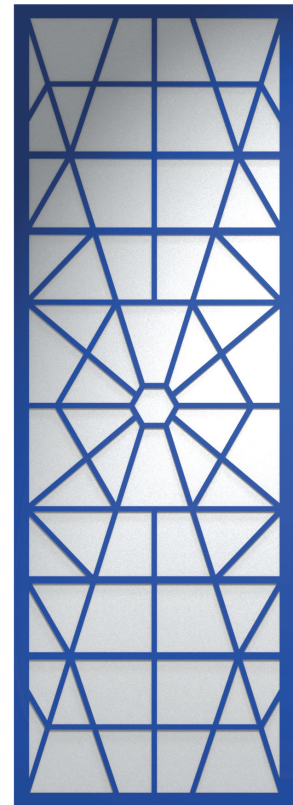

Technically superior:

Technically superior:

The design of the spider web support allows perfect tension of each of its surfaces making up the rectangle. Because a perfectly stretched mesh is a mesh that filters well and does not wear out quickly.

The support is welded to the mesh over the entire surface of its upper point. The triangular section of the support makes it easy to pick up large impurities that arrive in the drum such as sand for example.

The mesh and the triangular sections of the support are perfectly cleaned by the nozzles.

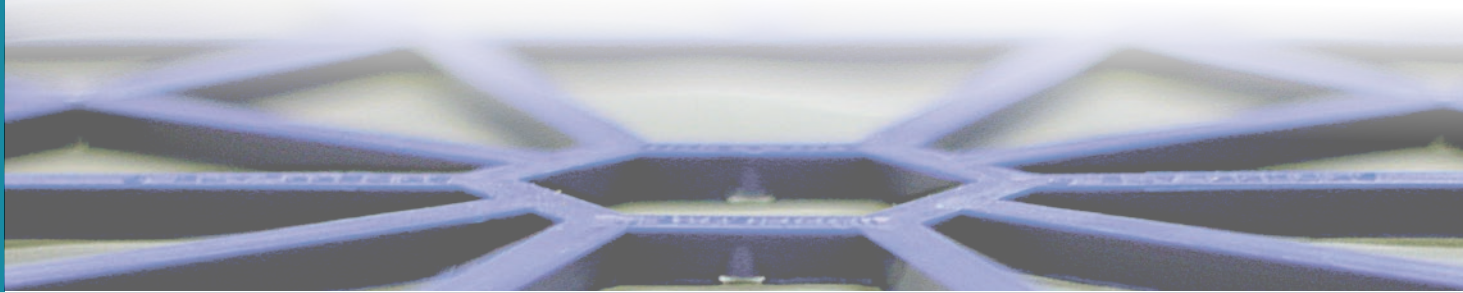

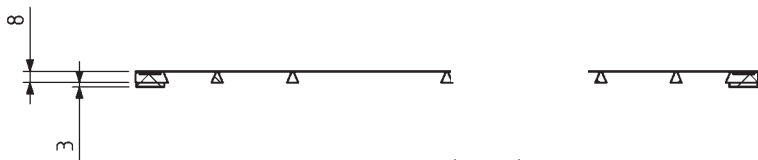
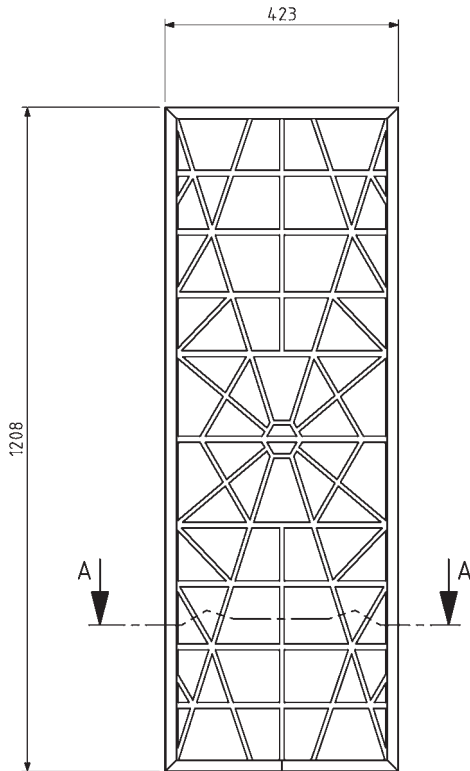

A-A (1 : 5)

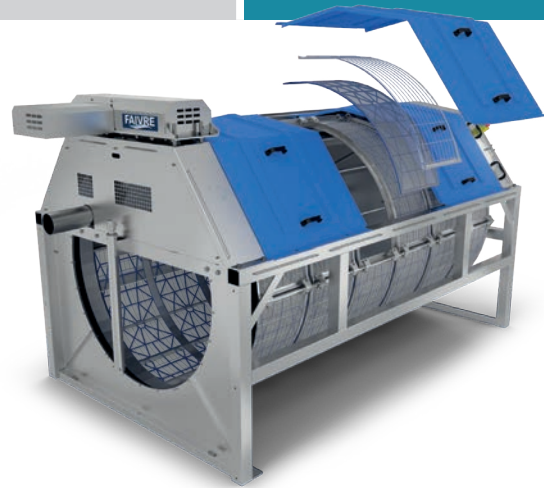

Matère cadre Frame material	PP No-Break
Matière toile / Mesh material	PA 6.6
Largeur / Width	423 mm
Longueur / Length	1208 mm
Epaisseur / Height	8 mm
Epaisseur joint Height seal	3 mm
% vide du cadre % empty frame	94,2%
Poids net Net Weight	0,82 kg 1,8 lbs

Fusion/Fused mesh :

La maille nylon est fusionnée dans le cadre polypropylène (PP) par un procédé unique.

The nylon mesh is fused into the polypropylene (PP) frame by a unique process.

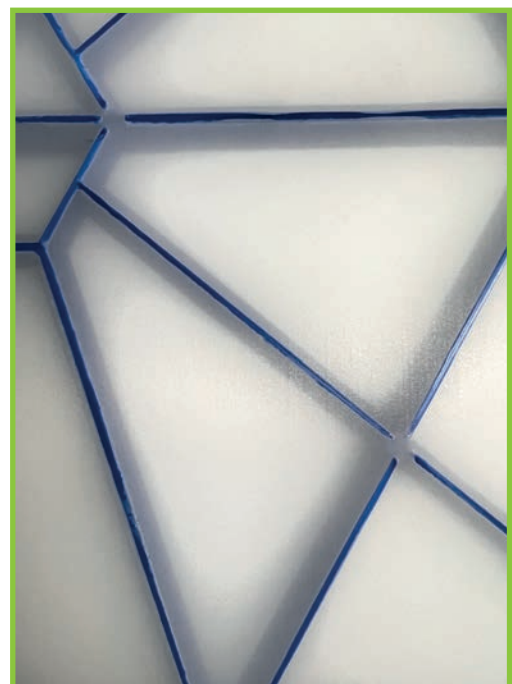

● **Drum filter**
Rotoclean

● Frame

● Input by pipe

● Stainless steel tank

● HDPE tank

● **Serie 40**



Flow rate up to 50 m3/h (220gpm) at 100 μ

● **Serie 60**



Flow rate up to 195 m3/h (860 gpm) at 100 μ

● **Serie 80**



Flow rate up to 650 m3/h (2860 gpm) at 100 μ

● **Serie 120**

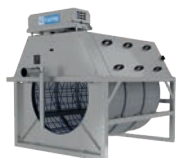

Flow rate up to 1008 m3/h (4438 gpm) at 100 μ

● **Serie 160**



Flow rate up to 2700 m3/h (11890 gpm) at 100 μ

● **Serie 200**



Flow rate up to 3510 m3/h (15450 gpm) at 100 μ



40

DrumFilter

Serie



www.faire-aqua.com



43 m3/h



15 / 500 µm



1 Size

Drum filter 40 serie

4 Models

Frame



Input by pipe



Stainless style tank



HDPE tank



Drum filter 40

Flow rate up to 12 l/s (43 m3/h) at 100 µ.

With a 40cm diameter drum, the Rotoclean 40 is the smallest filter in the Rotoclean drum filter range. Its size and light weight allow it to be installed very quickly in tight spaces. Built entirely in stainless steel. Its 40 cm diameter drum rotates at 17 rpm.

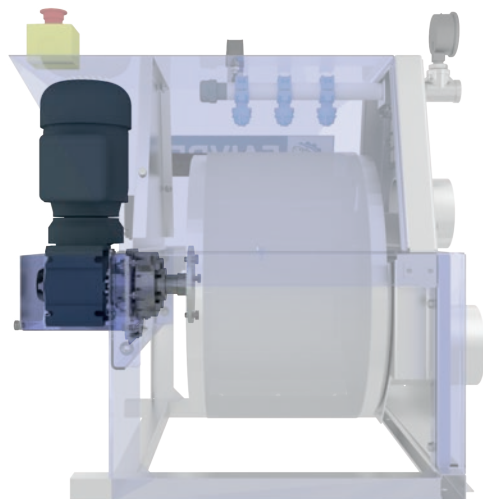

Direct Drive.

The Rotoclean 40 drum filter benefits from direct drive, because its drum is directly held in the motor reducer. This solution is simple and robust.

Rinsing ramp with optimized water consumption and pressure.

The Rotoclean Series 40 drum filter has only 3 rinsing nozzles, which saves rinsing water.

This saving is appreciable in small closed circuits where this filter is often used.

In addition, the pressure of the nozzles has been optimized in order to obtain a perfect rinsing of the fabrics without damaging them.

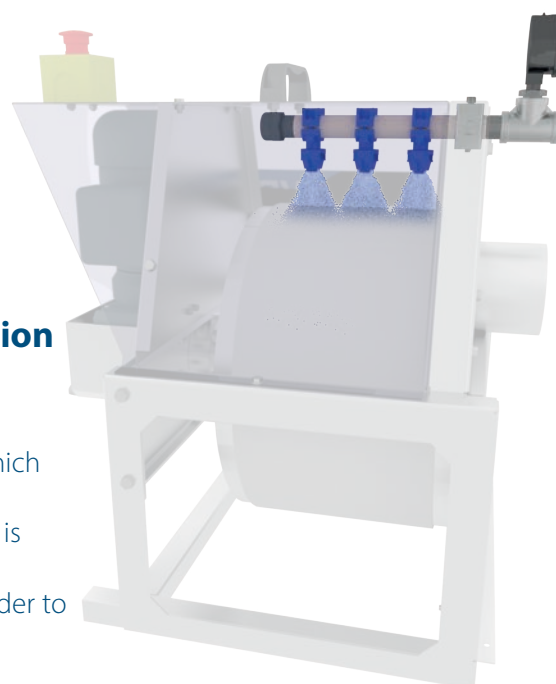

40
Rotoclean

www.faivregroup.com

Pictures and technical data are not contractual. FAIVRE Sasu can bring to its equipments any modifications required, at any time.

Specifications

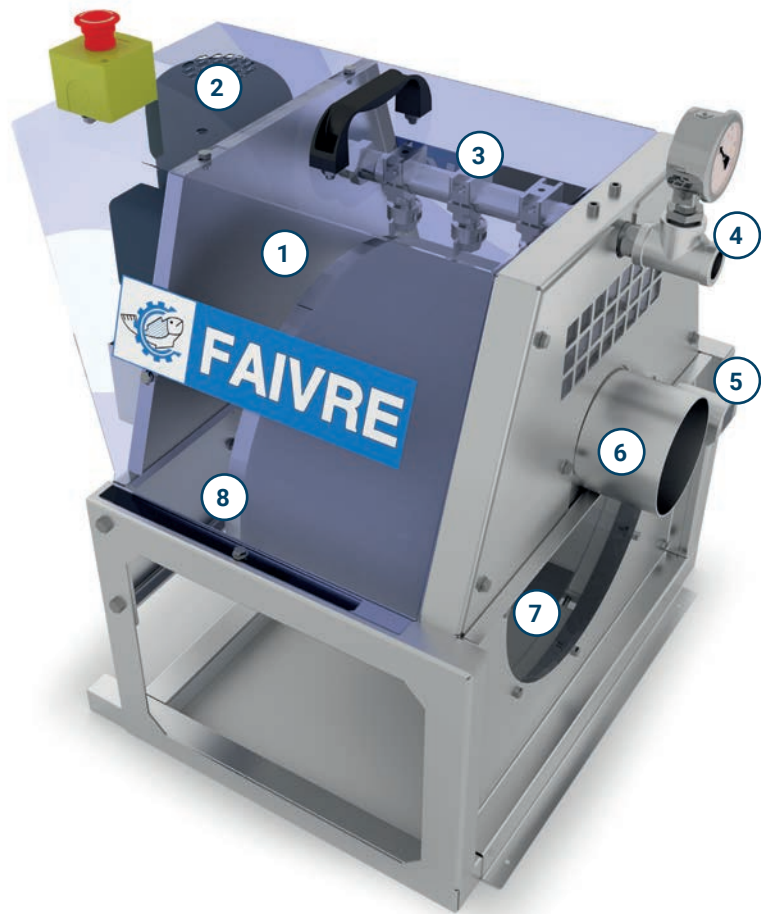

- 1 - Removable drum cover
- 2 - Drum drive motor reducer
- 3 - Rinsing ramp
- 4 - Rinsing manifold pressure gauge
- 5 - Level probe (option)
- 6 - Sludge outlet
- 7 - Water inlet to be filtered
- 8 - Stainless steel drum

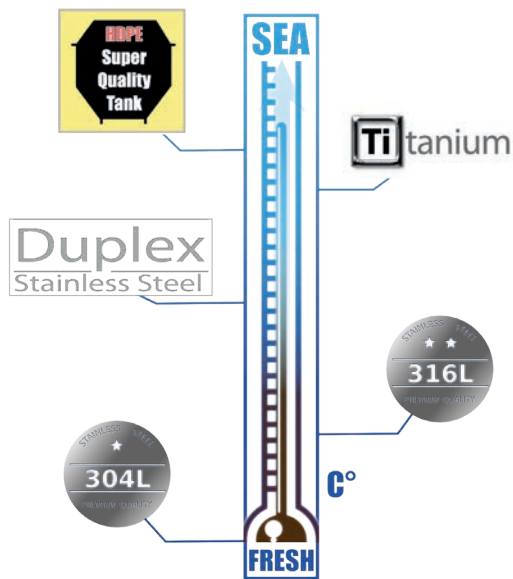

High quality stainless steel construction.

Exclusive use of high quality stainless steel made in northern Europe (Norway, Finland, Sweden)

- Stainless steel AISI 304L (4301) for fresh water as standard
- Stainless steel AISI 316L (4404) for sea water as standard
- Stainless steel DUPLEX (2205), HDPE and Titanium for hot sea water.

The CCPUs of the material constituting your filter order can be supplied to you on request.

Inlet - outlet standard	Motor power	Filter surface	Number of plates	Sludge outlet diameter	Number of Spray nozzles
Ø 125mm (6 l/s max.)	250 W	0,24 m ²	1	Ø 110 mm	3



• Frame



Net Weight	47 kg 104 lbs	
Unit	cm	in
Length	62	25
Width	56	21
Height	67	26

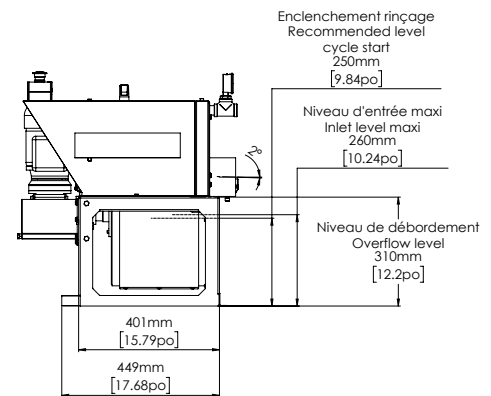
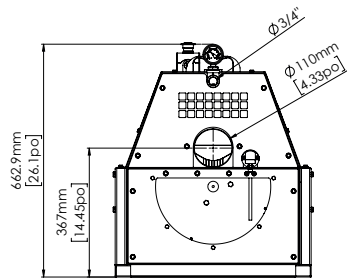
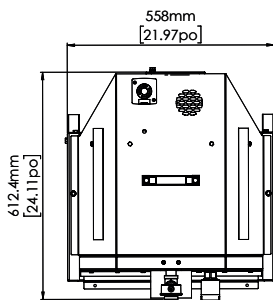

• Input by pipe



Net Weight	50 kg 110 lbs	
Unit	cm	in
Length	72	28
Width	56	22
Height	66	26

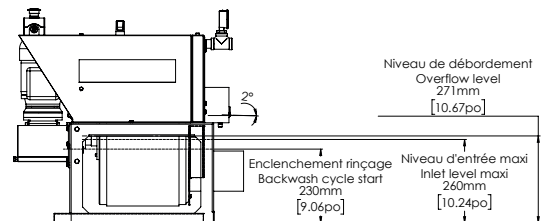
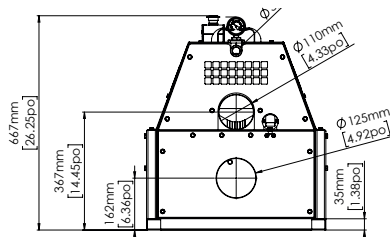
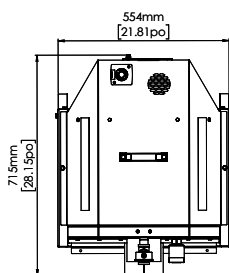

• Stainless steel tank



Net Weight	78 kg 172 lbs	
Weight full tank	110 kg 242 lbs	
Unit	cm	in
Length	70	27
Width	55	21
Height	67	26

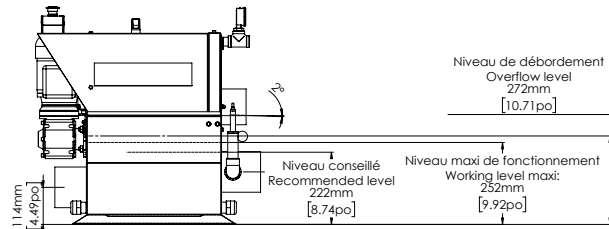
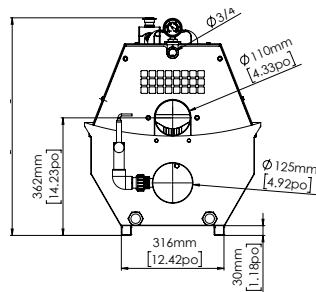
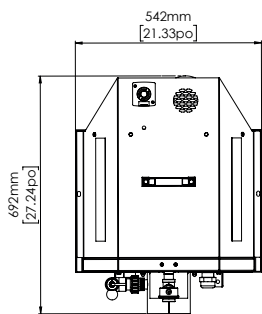

• HDPE tank



Net Weight	45 kg 99 lbs	
Weight full tank	110 kg 242 lbs	
Unit	cm	in
Length	71	28
Width	56	22
Height	69	26

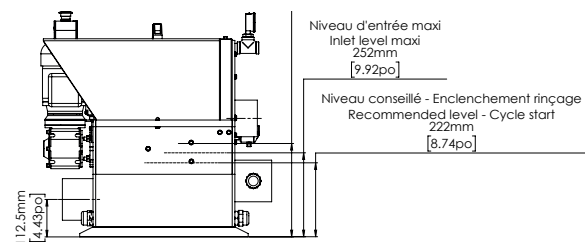
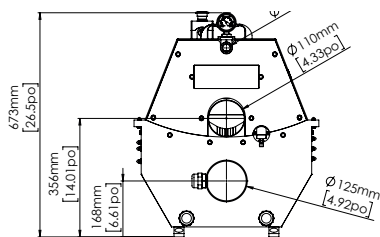
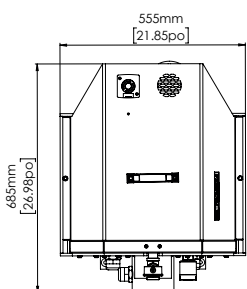

Options



Rinsing pump.

Vertical pump used for cleaning filter meshes. This pump is connected to the filter unclogging ramp. Its pressure is calculated so as to be adapted to the mesh of the filter.

In option the pump is delivered with all the accessories for connection to the drum filter.

Control box.

The control box is optional. It provides optimum control and safety for all our drum filters.

For the safety of people, the box includes:

- 1 lockable disconnecter.
- 2 emergency stops including 1 on the front of the cabinet, 1 other emergency stop is positioned on the drum filter.
- 1 fast-tripping current detector is also integrated in the box.

This current detector allows the filter to stop instantly in the event that the filter suddenly becomes blocked. (which can happen when an oversized foreign body enters the filter with the water)

For the safety of the equipment, the box includes:

- 1 circuit breaker unit for the power supply to the cabinet.
- 2 thermal circuit breakers to protect the motor of the drum filter and the motor of the rinsing pump.

The control box is delivered with:

- 5 m cable for the power supply.
- 10 m cable with M23 connector to easily connect the drum motor, the flushing pump, the emergency stop and the hood safety switch.
- 10 m of cable with an M12 connector to easily connect the water level radar.

Ref. : - **FTC001-EAS**

Power supply 3 x 200 - 230 - 400 - 440 - 480 - 575 V 50Hz/60Hz



Level probe and (or) Timer

A level probe and a timer are 2 possible options in order to control the operation of the drum filter.

The level probe is a high-performance radar which only takes into account the level of the liquid and which is not disturbed by foam on the surface of the filtered liquid.

The timer allows the drum to be started and stopped by simple programming on the component inside the cabinet using a screwdriver.

These two options are available separately or together on the boxes, please specify this when ordering.

Ref. :

- **FTDSN4** Level radar **LR2050**

- **FTDT01** Cabinet timer **FTC001-EAS**



RADAR



TIMER



60

DrumFilter

Serie





58 m3/h



15 / 500 µm



2 Sizes

Drum filter 60
serie

4 Models



Frame



Input by pipe

Drum filter 60

Flow rate up to 16 l/s (58 m3/h) at 100 µ.

Its size and light weight allow it to be installed very quickly in tight spaces.

It is ideal for small closed circuits, laboratories, test stations etc ...

Built entirely in stainless materials or technical plastic, it is insensitive to corrosion.

Its 60 cm diameter drum rotates at 8 revolutions per minutes.

Rinsing ramp with optimized water consumption and pressure.

The Rotoclean Series 60 drum filter has only 4 nozzles or 8 rinsing nozzles, this saves the rinsing water.

This saving is appreciable in small closed circuits where this filter is often used.

In addition, the pressure of the nozzles has been optimized in order to obtain a perfect rinsing of the fabrics without damaging them.

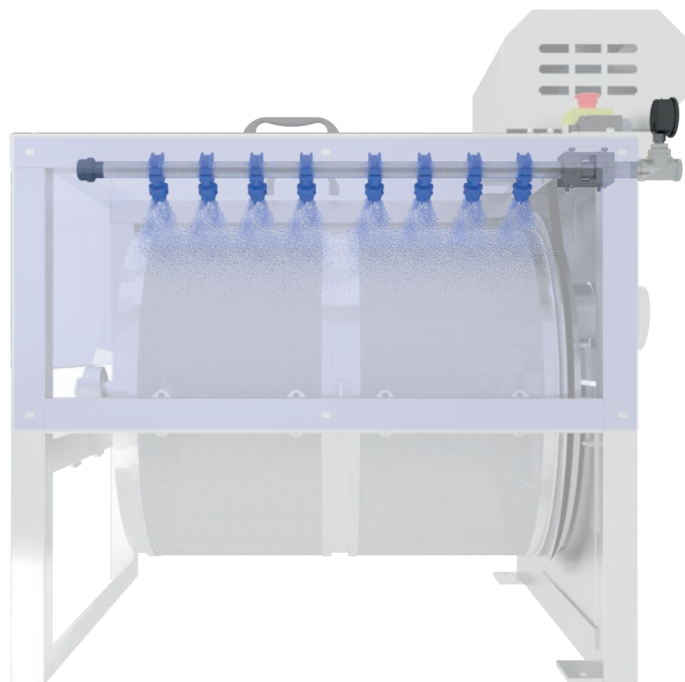

60
Rotoclean

www.faivregroup.com

Pictures and technical data are not contractual. FAIVRE Sasu can bring to its equipments any modifications required, at any time.

Specifications

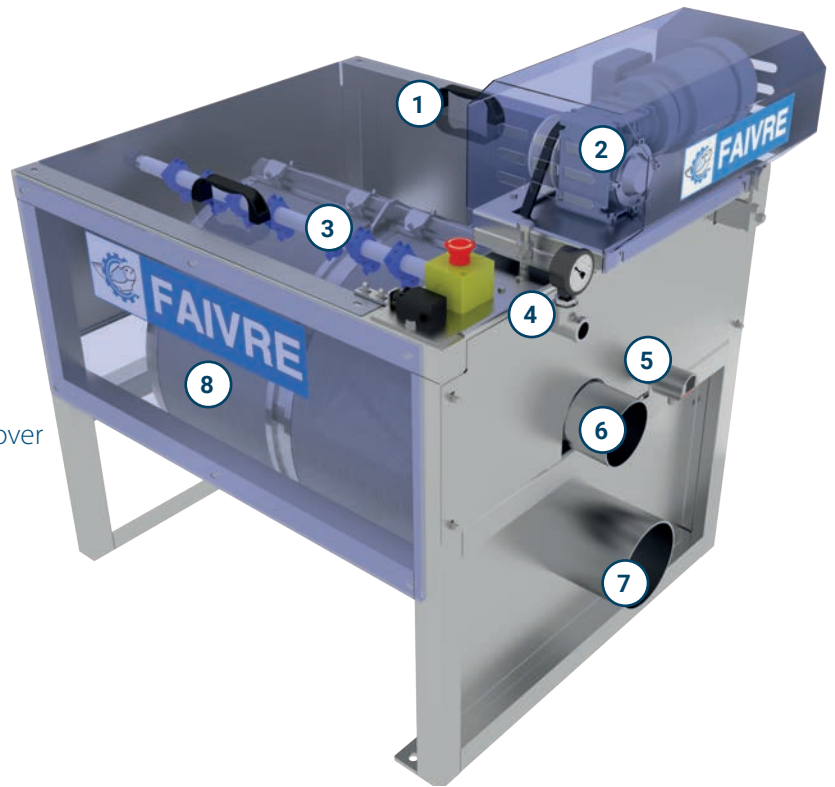

- 1 - Removable drum cover
- 2 - Drum drive motor under stainless steel cover
- 3 - Rinsing ramp
- 4 - Rinsing manifold pressure gauge
- 5 - Level probe (option)
- 6 - Sludge outlet
- 7 - Water inlet to be filtered
- 8 - Stainless steel drum

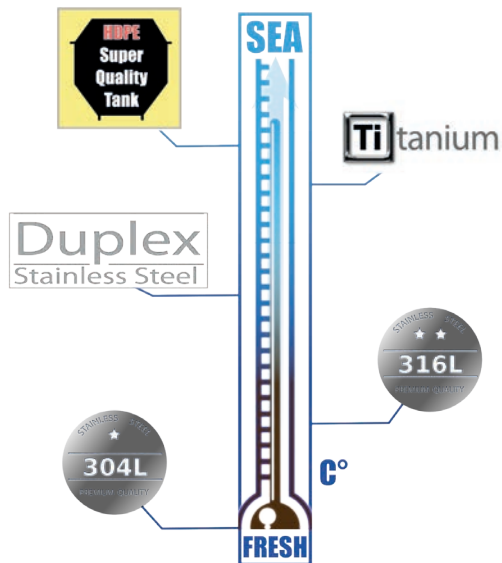

High quality stainless steel construction.

- Exclusive use of high quality stainless steel made in northern Europe (Norway, Finland, Sweden)
- Stainless steel AISI 304L (4301) for fresh water as standard
 - Stainless steel AISI 316L (4404) for sea water as standard
 - Stainless steel DUPLEX (2205), HDPE and Titanium for hot sea water.

The CCPUs of the material constituting your filter order can be supplied to you on request.

Model	Inlet -outlet standard	Motor power	Filter surface	Number of plates	Sludge outlet diameter	Number of Spray nozzles
2 - 60	Ø125mm (6l/s max.)	250 W	0,5 m ²	2	Ø 110 mm	4
4 - 60	Ø160mm (16l/s max.) Ø200mm (25l/s max.)		1 m ²	4		8



Frame



	2 - 60		4 - 60	
Net Weight	115 kg 253 lbs		140 kg 308 lbs	
Unit	cm	in	cm	in
Width	84	33	84	33
Height	106	41	106	41
Length (A)	56	22	90	35
Length (B)	71	28	105	41

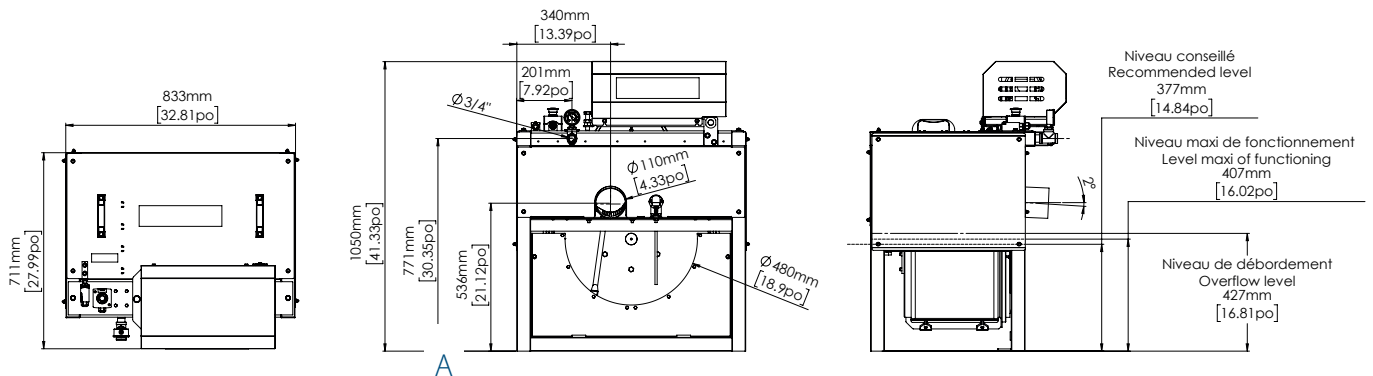

Input by pipe



	2 - 60		4 - 60	
Net Weight	121 kg 267 lbs		145 kg 319 lbs	
Unit	cm	in	cm	in
Width	83	33	83	33
Height	105	41	105	41
Length (A)	60	23	95	37
Length (B)	72	28	107	42

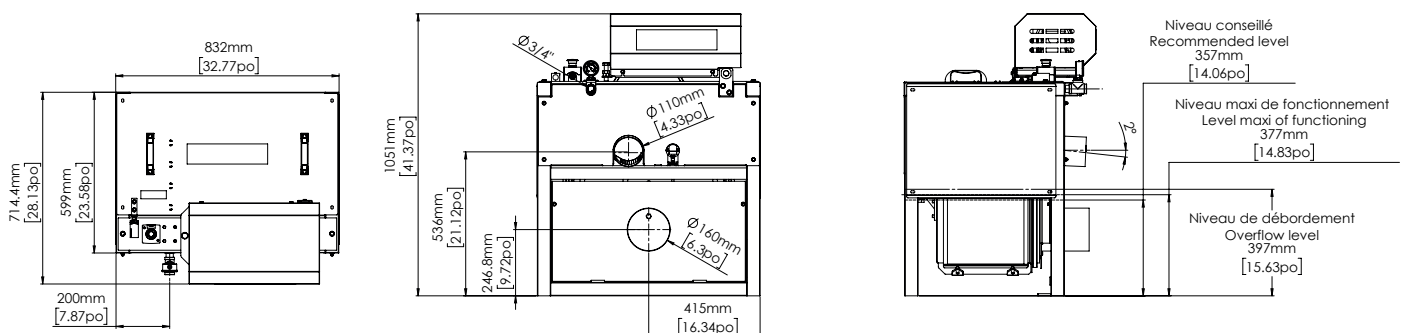

Stainless steel tank



	2 - 60		4 - 60	
Net Weight	126 kg 278 lbs		155 kg 341 lbs	
Net weight full tank	390 kg 860 lbs		600 kg 1322 lbs	
Unit	cm	in	cm	in
Width	83	32	83	32
Height	104	41	104	41
Length (A)	62	24	97	38
Length (B)	89	35	123	48

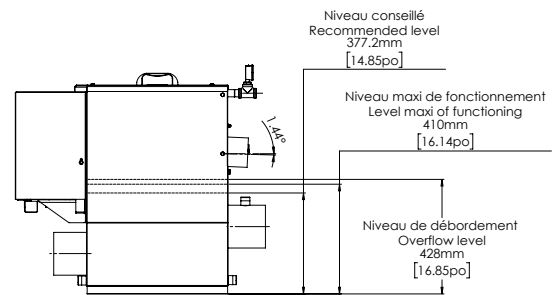
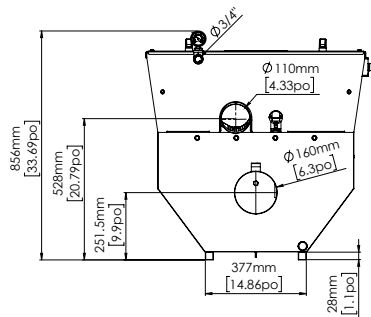
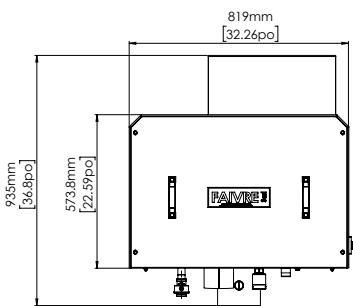

HDPE tank



	2 - 60		4 - 60	
Net Weight	140 kg 309 lbs		160 kg 352 lbs	
Net weight full tank	390 kg 860 lbs		600 kg 1322 lbs	
Unit	cm	in	cm	in
Width	85	33	85	33
Height	87	34	87	34
Length (A)	54	21	89	35
Length (B)	95	37	130	51

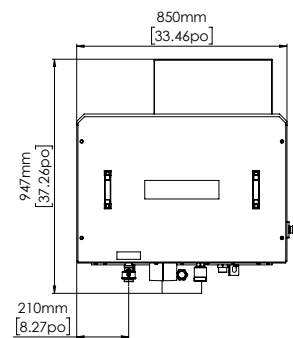
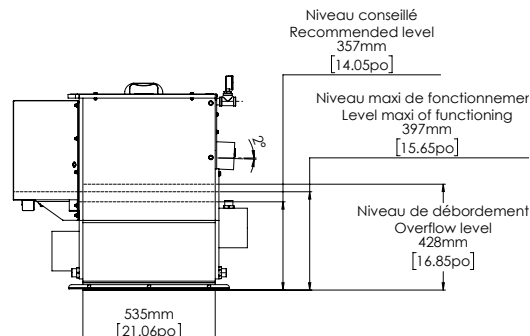
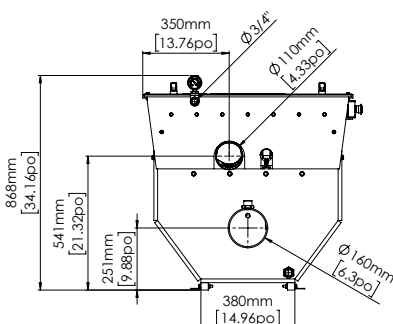

Options

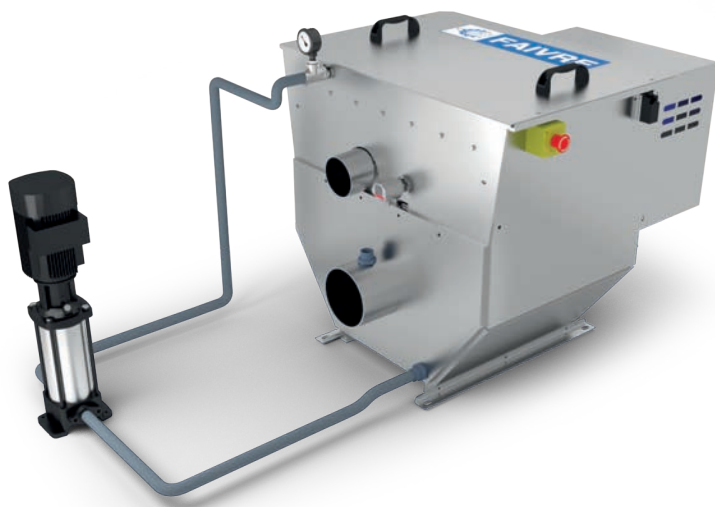

Rinsing pump.

Vertical pump used for cleaning filter meshes. This pump is connected to the filter unclogging ramp. Its pressure is calculated so as to be adapted to the mesh of the filter.

The pump is delivered with all the accessories for connection to the drum filter.

Control box.

The control box is optional. It provides optimum control and safety for all our drum filters.

For the safety of people, the box includes:

- 1 lockable disconnecter.
- 2 emergency stops including 1 on the front of the cabinet, 1 other emergency stop is positioned on the drum filter.
- 1 fast-tripping current detector is also integrated in the box. This current detector allows the filter to stop instantly in the event that the filter suddenly becomes blocked. (which can happen when an oversized foreign body enters the filter with the water)

For the safety of the equipment, the box includes:

- 1 circuit breaker unit for the power supply to the cabinet.
- 2 thermal circuit breakers to protect the motor of the drum filter and the motor of the rinsing pump.

The control box is delivered with:

- 5m cable for the power supply.
- 10m cable with M23 connector to easily connect the drum motor, the flushing pump, the emergency stop and the hood safety switch.
- 10m of cable with an M12 connector to easily connect the water level radar.

Ref. : - **FTC001-EAS**

Power supply 3 x 200 - 230 - 400 - 440 - 480 - 575 V 50Hz / 60Hz

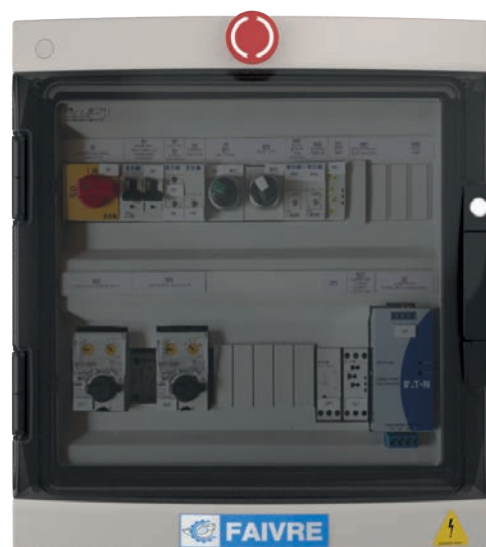

Level probe and (or) Timer

A level probe and a timer are 2 possible options in order to control the operation of the drum filter.

The level probe is a high-performance radar which only takes into account the level of the liquid and which is not disturbed by foam on the surface of the filtered liquid.

The timer allows the drum to be started and stopped by simple programming on the component inside the cabinet using a screwdriver.

These two options are available separately or together on the boxes, please specify this when ordering.

Ref. :

- **FTDSN4** Level radar **LR2050**

- **FTDT01** Cabinet timer **FTC001-EAS**



RADAR



TIMER

Installation examples

FT60 Frame

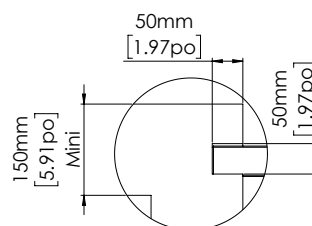
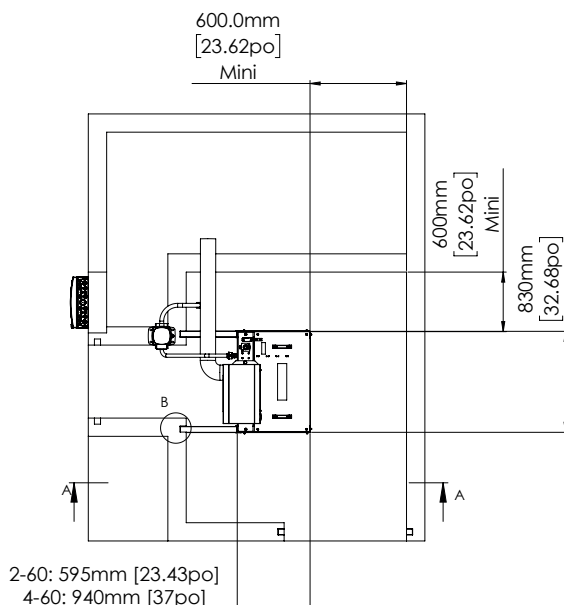
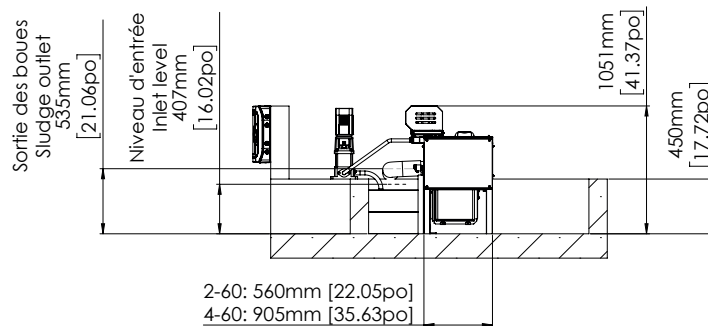

Invalid document for construction

80

DrumFilter

Serie



www.favregroup.com



Drum filter 80 serie

4 Models

Frame



Input by pipe



Stainless style tank



HDPE tank



Drum filter 80

Flow rate up to 135 l/s (486 m3/h) at 100 µ.

With an 80 cm diameter drum, the Rotoclean 80 can treat reasonable amounts of water. It is available in 4 sizes (2, 4, 6 and 8 plates).

The Rotoclean 80 finds its place in closed circuits in both freshwater and seawater. It is also commonly used in aquaponics farms.

Built entirely in stainless steel and technical plastic, it is not very sensitive to corrosion.

Its 80 cm diameter drum rotates at 5 revolutions per minutes.

BDS simple, reliable and robust system.

Rotoclean 80 drum filters benefit from the BDS system (Belt Drive & Support system). The motor, ideally placed on top of the drum filter, drives and supports the drum with one or more belts.

In 20 years of experience, this system has shown all its advantages:

- Soft start by nature (does not require a soft start with a frequency converter)
- Reliability over time (more than 5 years without maintenance)
- Transmission does not break if the drum jams (for example: if an object enters the drum)



Rinsing ramp with optimized water consumption and pressure.

The pressure of the nozzles has been optimized in order to obtain a perfect rinsing of the fabrics without damaging them.

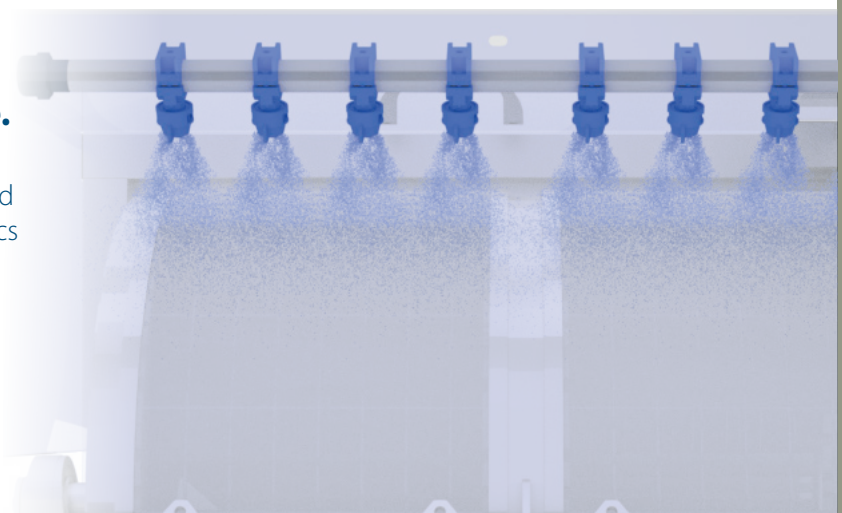

www.faivregroup.com

Pictures and technical data are not contractual. FAIVRE Sasu can bring to its equipments any modifications required, at any time.

80

Rotoclean

Our Rotoclean 80 drum filters are compatible with :

- Smart filter technology (page 10)

Smart filter



Specifications

Model	Inlet -outlet standard	Motor power	Filter surface	Number of plates	Sludge outlet diameter	Number of Spray nozzles
2 - 80	Ø 200 mm (25l/s max.) Ø 250 mm (39l/s max.) Ø 315 mm (62l/s max.)	250 W	0,86 m ²	2	Ø 110 mm	5
4 - 80			1,72 m ²	4		10
6 - 80			2,58 m ²	6		15
8 - 80			3,44 m ²	8		20

- 1 - Drum drive motor under stainless steel cover
- 2 - Rinsing manifold pressure gauge
- 3 - Level probe
- 4 - Sludge outlet
- 5 - Stainless steel tank
- 6 - Removable stainless steel covers
- 7 - Rinsing ramp

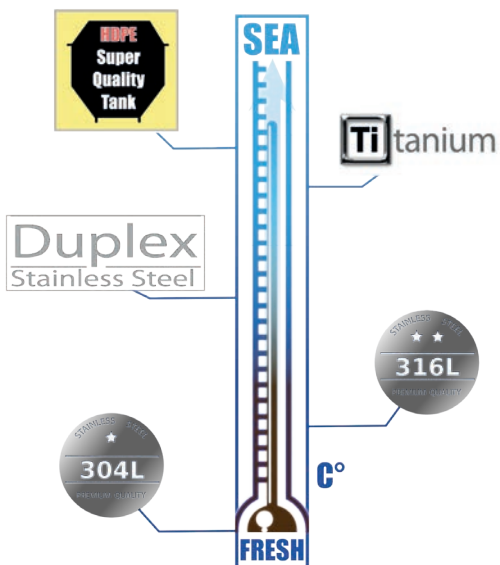
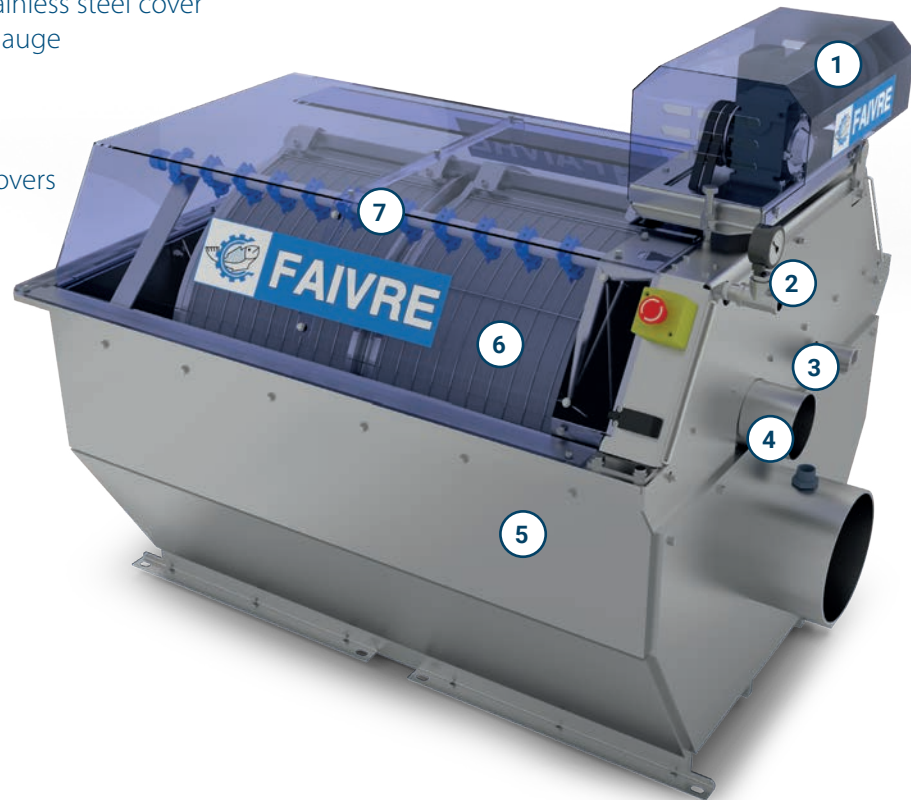

High quality stainless steel construction.

Exclusive use of high quality stainless steel made in northern Europe (Norway, Finland, Sweden)

- Stainless steel AISI 304L (4301) for fresh water as standard
- Stainless steel AISI 316L (4404) for sea water as standard
- Stainless steel DUPLEX (2205), HDPE and Titanium for hot sea water.

The CCPUs of the material constituting your filter order can be supplied to you on request.

www.faivregroup.com

Pictures and technical data are not contractual. FAIVRE Sasu can bring to its equipments any modifications required, at any time.

Frame



	2-80		4-80		6-80		8-80	
Net weight	185 kg 408 lbs		236 kg 520 lbs		293 kg 646 lbs		342 kg 754 lbs	
Unit	cm	in	cm	in	cm	in	cm	in
Width	106	42	106	42	106	42	106	42
Height	121	48	121	48	121	48	121	48
Length (A)	75	29	119	47	163	65	207	82
Length (B)	89	35	133	52	177	70	221	87

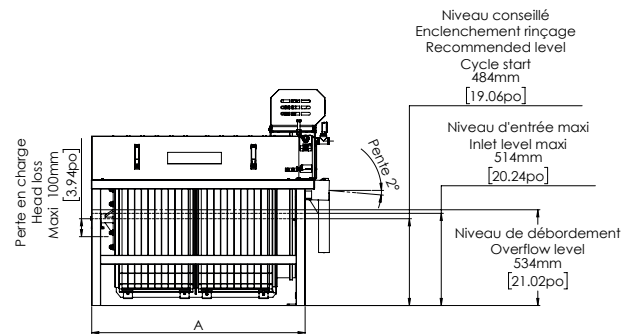
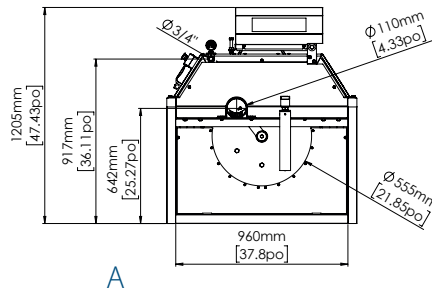
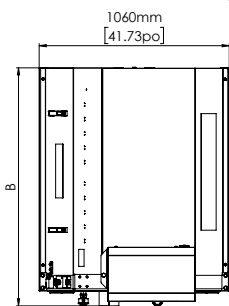

Input by pipe



	2-80		4-80		6-80		8-80	
Net weight	195 kg 430 lbs		245 kg 540 lbs		302 kg 666 lbs		-	
Unit	cm	in	cm	in	cm	in	cm	in
Width	106	42	106	42	106	42	106	42
Height	121	47	121	47	121	47	121	47
Length (A)	80	31	124	49	168	66	212	83
Length (B)	89	35	133	52	177	70	221	87

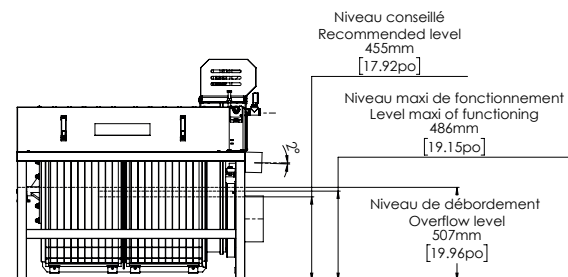
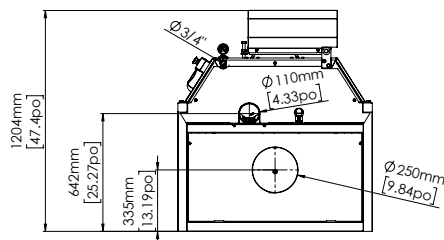
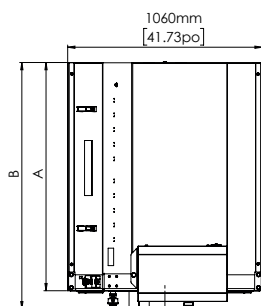

Stainless steel tank

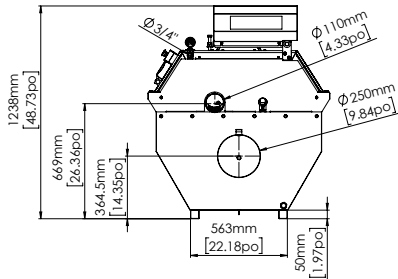
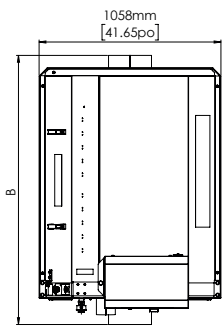

1058mm
[41.65po]

	2-80		4-80		6-80		8-80	
Net weight	219 kg	483 lbs	279 kg	615 lbs	345 kg	761 lbs	404 kg	891 lbs
Net weight full tank	635 kg	1400 lbs	900 kg	1984 lbs	1180 kg	2601 lbs	1460 kg	3219 lbs
Unit	cm	in	cm	in	cm	in	cm	in
Width	106	42	106	42	106	42	106	42
Height	124	49	124	49	124	49	124	49
Length (A)	85	33	129	51	173	68	217	85
Length (B)	112	44	156	62	200	79	244	96

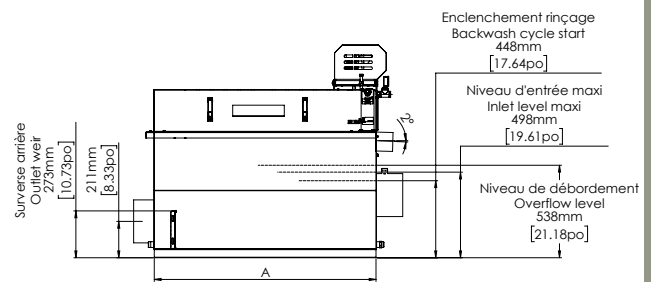

HDPE tank

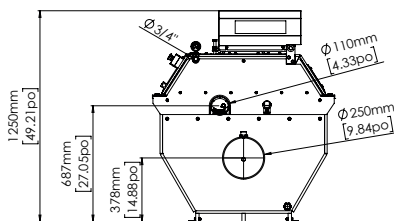
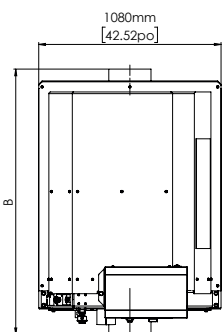
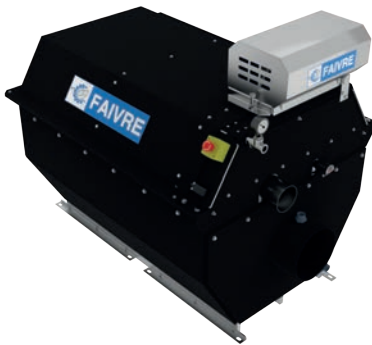

	2-80		4-80		6-80		8-80	
Net weight	219 kg	483 lbs	279 kg	615 lbs	345 kg	761 lbs	404 kg	891 lbs
Net weight full tank	635 kg	1400 lbs	900 kg	1984 lbs	1180 kg	2601 lbs	1460 kg	3219 lbs
Unit	cm	in	cm	in	cm	in	cm	in
Width	106	42	106	42	106	42	106	42
Height	124	49	124	49	124	49	124	49
Length (A)	85	33	129	51	173	68	217	85
Length (B)	112	44	156	62	200	79	244	96

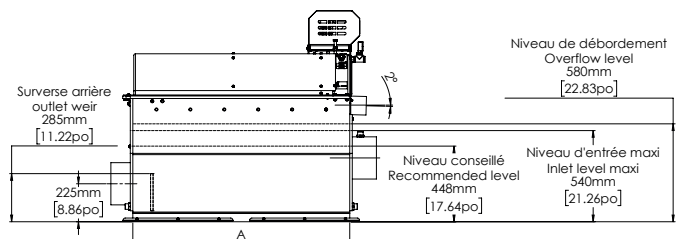

Options



Rinsing pump.

Vertical pump used for cleaning filter meshes. This pump is connected to the filter unclogging ramp. Its pressure is calculated so as to be adapted to the mesh of the filter.
The pump is delivered with all the accessories for connection to the drum filter.

Control box.

The control box is optional. It provides optimum control and safety for all our drum filters.

For the safety of people, the box includes:

- 1 lockable disconnecter.
- 2 emergency stops including 1 on the front of the cabinet, 1 other emergency stop is positioned on the drum filter.
- 1 fast-tripping current detector is also integrated in the box. This current detector allows the filter to stop instantly in the event that the filter suddenly becomes blocked. (which can happen when an oversized foreign body enters the filter with the water)

For the safety of the equipment, the box includes:

- 1 circuit breaker unit for the power supply to the cabinet.
- 2 thermal circuit breakers to protect the motor of the drum filter and the motor of the rinsing pump.

The control box is delivered with:

- 5m cable for the power supply.
- 10m cable with M23 connector to easily connect the drum motor, the flushing pump, the emergency stop and the hood safety switch.
- 10m of cable with an M12 connector to easily connect the water level radar.

Ref. : - **FTC001-EAS**

Power supply 3 x 200 - 230 - 400 - 440 - 480 - 575 V 50Hz / 60Hz



Level probe and (or) Timer

A level probe and a timer are 2 possible options in order to control the operation of the drum filter.

The level probe is a high-performance radar which only takes into account the level of the liquid and which is not disturbed by foam on the surface of the filtered liquid.

The timer allows the drum to be started and stopped by simple programming on the component inside the cabinet using a screwdriver.

These two options are available separately or together on the boxes, please specify this when ordering.

Ref. :

- **FTDSN4** Level radar **LR2050**

- **FTDT01** Cabinet timer **FTC001-EAS**



RADAR



TIMER

Installation examples

FT80 Frame

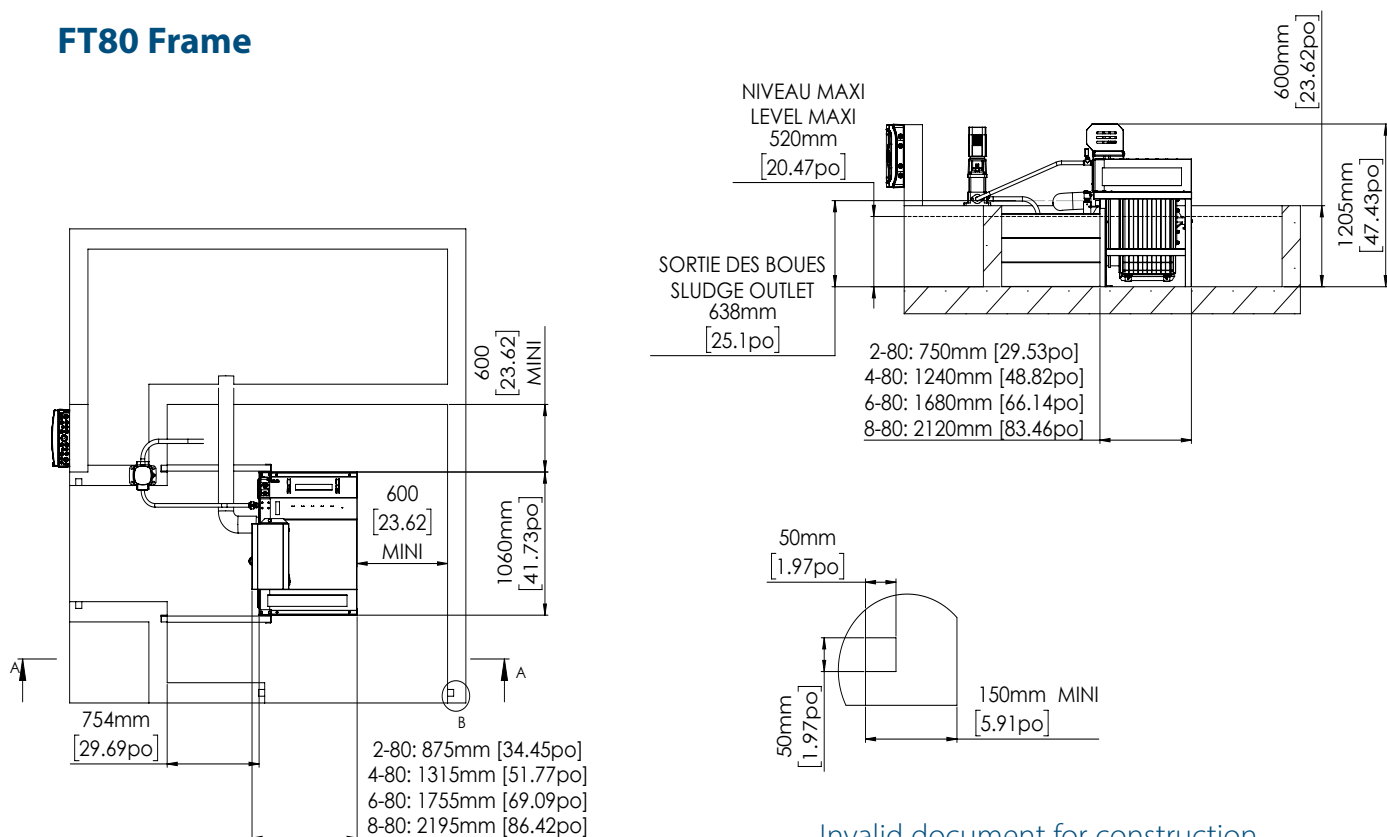

Invalid document for construction

120 DrumFilter

Serie





Drum filter 120 serie

4 Models

Frame



Input by pipe



Stainless style tank



HDPE tank



Drum filter 120

Flow rate up to 211 l/s (760 m³/h) at 100 µ.

With a 120cm diameter drum, the Rotoclean 120 can treat large quantities of water. It is available in 5 sizes (3, 6, 9, 12 and 15 plates).

The Rotoclean 120 finds its place in closed circuits in both freshwater and seawater.

Built entirely in stainless steel and technical plastic, it is not very sensitive to corrosion.

Its 120 cm diameter drum rotates at 5 revolutions / min.

BDS simple, reliable and robust system.

Rotoclean 120 drum filters benefit from the BDS system (Belt Drive & Support system). The motor, ideally placed on top of the drum filter, drives and supports the drum with one or more belts.

In 20 years of experience, this system has shown all its advantages:

- Soft start by nature (does not require a soft start with a frequency converter)
- Reliability over time (more than 5 years without maintenance)
- Transmission does not break if the drum jams (for example: if an object enters the drum)

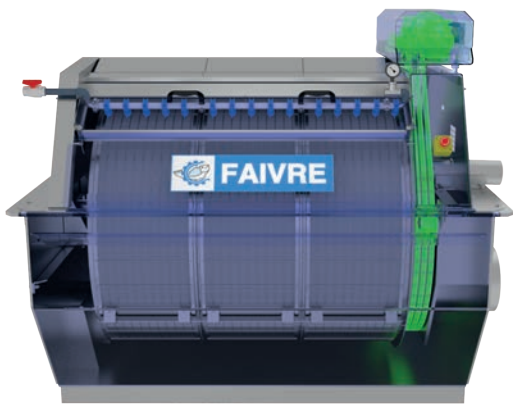

Rinsing ramp with optimized water consumption and pressure.

The pressure of the nozzles has been optimized in order to obtain a perfect rinsing of the fabrics without damaging them.

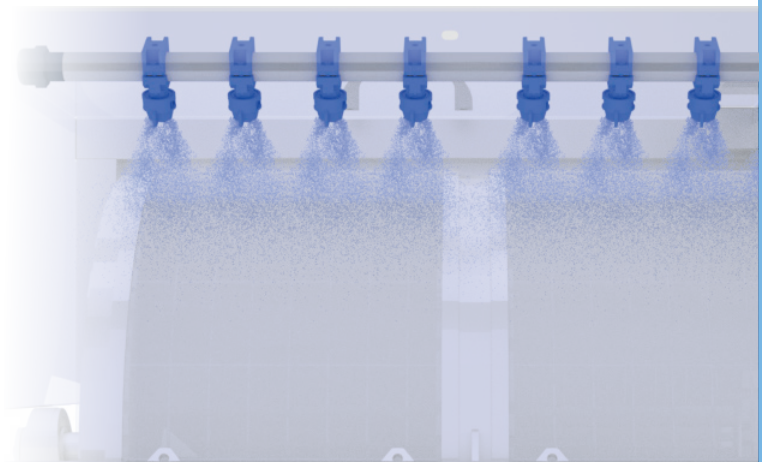

120
Rotoclean

Our Rotoclean 120 drum filters are compatible with :

- Smart filter technology (page 10)
- New Spiderplate® (page 12)

Smart filter



SPIDERPLATE

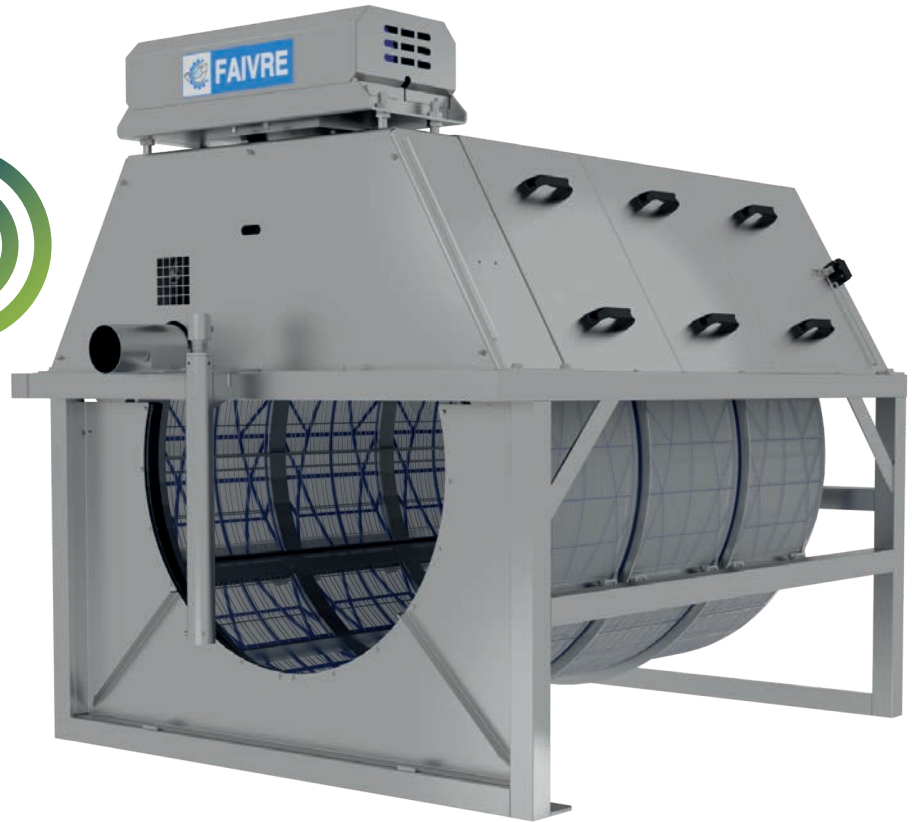

Specifications

Model	Ø Inlet -outlet in standard	Motor power	Filter surface	Number of plates	Sludge outlet diameter	Number of Spray nozzles
3 - 120	Ø 315 mm (62l/s max.) Ø 350 mm (79l/s max.) Ø 400 mm (105l/s max.)	370 W	1,29 m ²	3	Ø 110 mm	5
6 - 120			2,58 m ²	6		10
9 - 120			3,87 m ²	9		15
12 - 120			5,16 m ²	12		20



- 1 - Drum
- 2 - Removable stainless steel covers
- 3 - Drum drive motor under stainless steel cover
- 4 - Level probe
- 5 - Sludge outlet
- 6 - Stainless steel tank
- 7 - Rinsing manifold pressure gauge
- 8 - Rinsing ramp

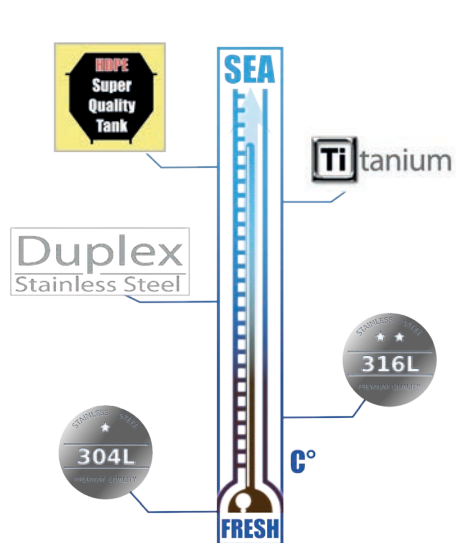

High quality stainless steel construction.

- Exclusive use of high quality stainless steel made in northern Europe (Norway, Finland, Sweden)
- Stainless steel AISI 304L (4301) for fresh water as standard
 - Stainless steel AISI 316L (4404) for sea water as standard
 - Stainless steel DUPLEX (2205), HDPE and Titanium for hot sea water.

The CCPUs of the material constituting your filter order can be supplied to you on request.

www.faivregroup.com

Pictures and technical data are not contractual. FAIVRE Sasu can bring to its equipments any modifications required, at any time.

Frame

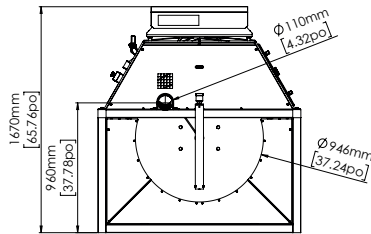
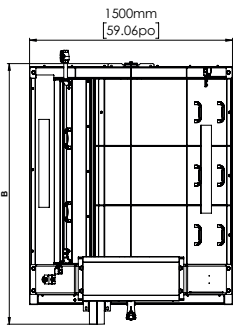

	3-120		6-120		9-120		12-120	
Net weight	340 kg 749 lbs		420 kg 926 lbs		498 kg 1098 lbs		588 kg 1296 lbs	
Unit	cm	in	cm	in	cm	in	cm	in
Width	150	59	150	59	150	59	150	59
Height	167	66	167	66	167	66	167	66
Length (A)	76	30	120	47	164	64	208	82
Length (B)	104	41	148	59	192	76	236	93

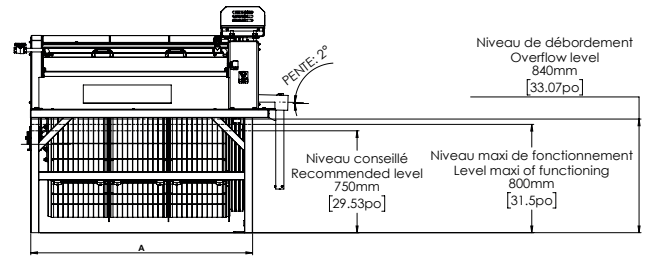

A

Input by pipe

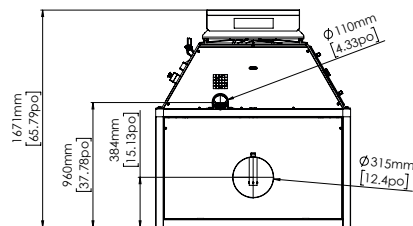
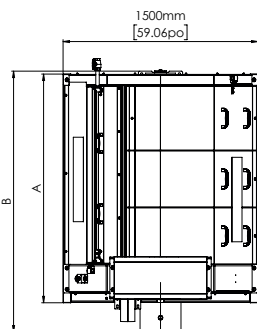

	3-120		6-120		9-120		12-120	
Net weight	372 kg 820 lbs		457 kg 1008 lbs		534 kg 1177 lbs		621 kg 1369 lbs	
Unit	cm	in	cm	in	cm	in	cm	in
Width	150	59	150	59	150	59	150	59
Height	167	64	167	64	167	64	167	64
Length (A)	87	34	131	51	175	69	219	86
Length (B)	113	44	157	62	201	79	245	96

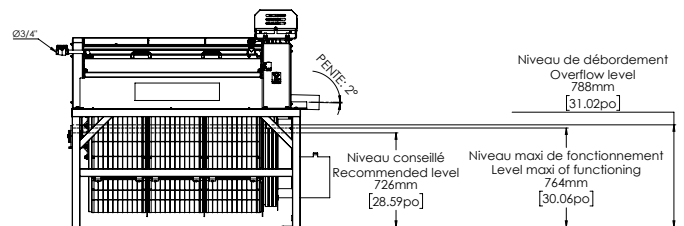

Stainless steel tank

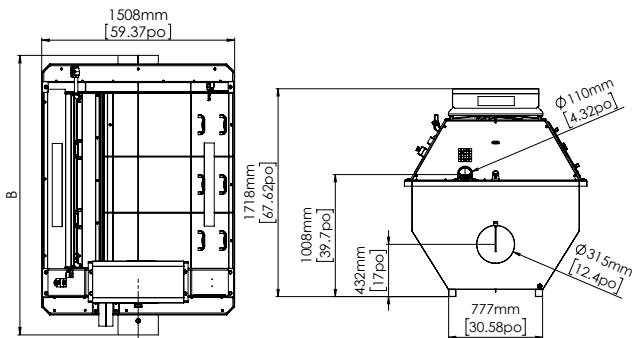

	3-120		6-120		9-120		12-120	
Net weight	395 kg 871 lbs		477 kg 1052 lbs		562 kg 1239 lbs		649 kg 1431 lbs	
Net weight full tank	1370 kg 3020 lbs		2000 kg 4409 lbs		2560 kg 5644 lbs		3250 kg 7165 lbs	
Unit	cm	in	cm	in	cm	in	cm	in
Width	150	59	150	59	150	59	150	59
Height	172	68	172	68	172	68	172	68
Length (A)	95	37	139	55	183	72	227	89
Length (B)	130	51	174	68	218	86	262	103

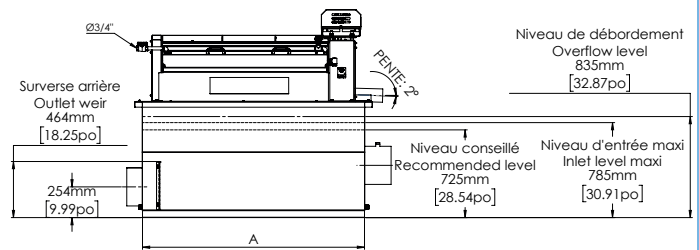

HDPE tank

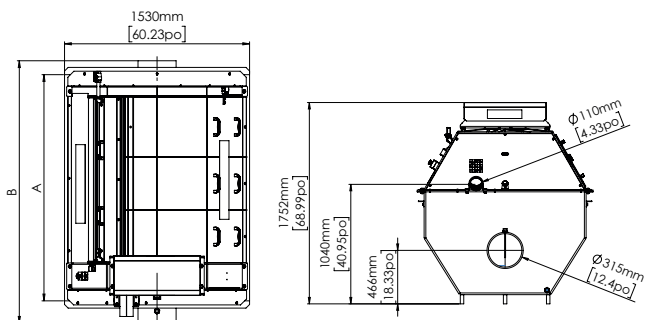

	3-120		6-120		9-120		12-120	
Net weight	-		475 kg 1047 lbs		572 kg 1261 lbs		-	
Net weight full tank	-		2000 kg 4409 lbs		2560 kg 5644 lbs		-	
Unit	cm	in	cm	in	cm	in	cm	in
Width	-	-	153	60	153	60	-	-
Height	-	-	175	69	175	69	-	-
Length (A)	-	-	139	55	183	72	-	-
Length (B)	-	-	173	68	217	85	-	-

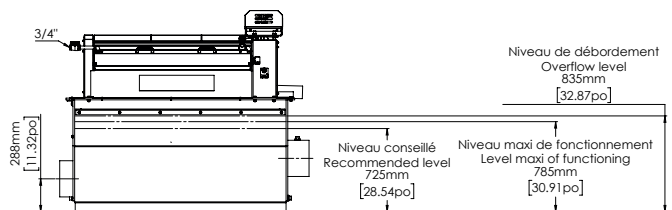

Options

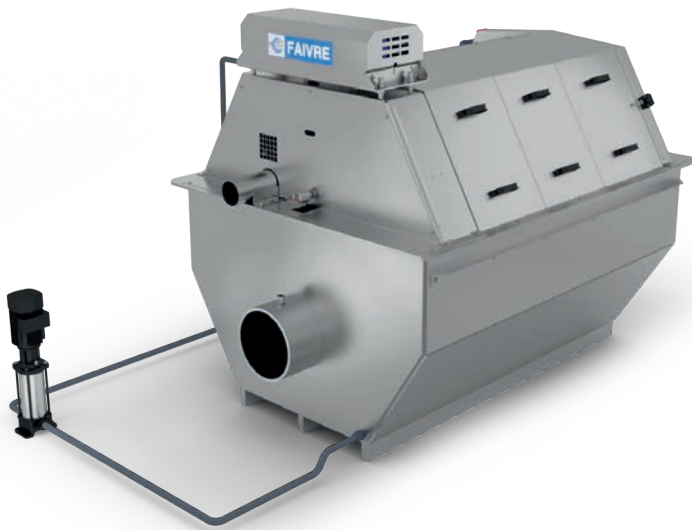

Rinsing pump.

Vertical pump used for cleaning filter meshes. This pump is connected to the filter unclogging ramp. Its pressure is calculated so as to be adapted to the mesh of the filter.
The pump is delivered with all the accessories for connection to the drum filter.

Control box with polyester box.

The control box is optional. It allows optimum control and safety for all our drum filters.

The large IP65 polyester box is more suitable for model 120, 160 or 200 filters.

For the safety of people, the box includes:

- 1 lockable disconnecter.
- 2 emergency stops including 1 on the front of the cabinet, 1 other emergency stop is positioned on the drum filter.
- 1 fast-tripping current detector is also integrated in the box. This current detector allows the filter to stop instantly in the event that the filter suddenly becomes blocked. (which can happen when a foreign body that is too large enters the filter with the water)

For the safety of the equipment, the box includes:

- 1 circuit breaker unit for the power supply to the cabinet.
- 2 thermal circuit breakers to protect the motor of the drum filter and the motor of the rinsing pump.

The control box is delivered with:

- 5m cable for the power supply.
- 10m cable with M23 connector to easily connect the drum motor, the flushing pump, the emergency stop and the hood safety switch.
- 10m of cable with an M12 connector to easily connect the water level radar.

Ref. :

- FTC021-B24

Power supply 3 x 200 - 230 - 400 - 440 - 480 - 575 V 50Hz/60Hz

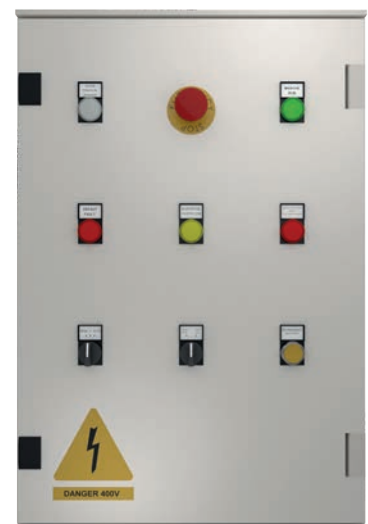

Level probe and (or) Timer

A level probe and a timer are 2 possible options in order to control the operation of the drum filter.

The level probe is a high-performance radar which only takes into account the level of the liquid and which is not disturbed by foam on the surface of the filtered liquid.

The timer allows the drum to be started and stopped by simple programming on the component inside the cabinet using a screwdriver.

These two options are available separately or together on the boxes, please specify this when ordering.

Ref. :

- **FTDSN4** Level radar **LR2050**

- **FTDT01** Cabinet timer **FTC001-EAS**



RADAR



TIMER

Installation examples

FT120 Frame

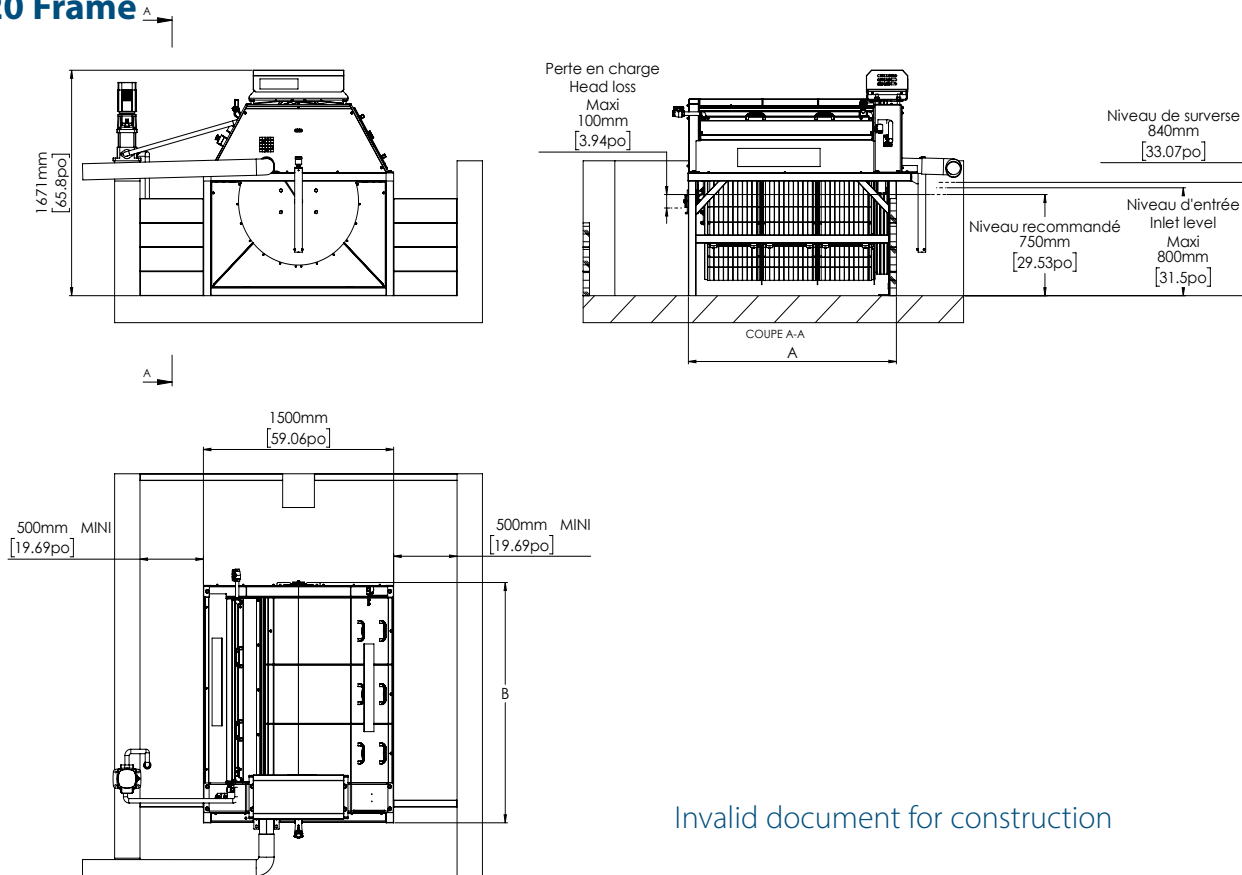

Invalid document for construction

160 DrumFilter

Serie



www.favregroup.com



Drum filter 160 serie

4 Models

Frame



Input by pipe



Stainless style tank



HDPE tank



Drum filter 160

Flow rate up to 750 l/s (2700 m³/h) at 100 µ.

With a 160cm diameter drum, the Rotoclean 160 can handle large quantities of water. It is available in 7 sizes (8, 12, 16, 20, 24, 28 and 32 plates).

The Rotoclean 160 finds its place in closed circuits in freshwater as well as in seawater as well as at the site exit. Built entirely in stainless steel and technical plastic, it is not very sensitive to corrosion.

Its 160 cm diameter drum rotates at 3 revolutions/min.

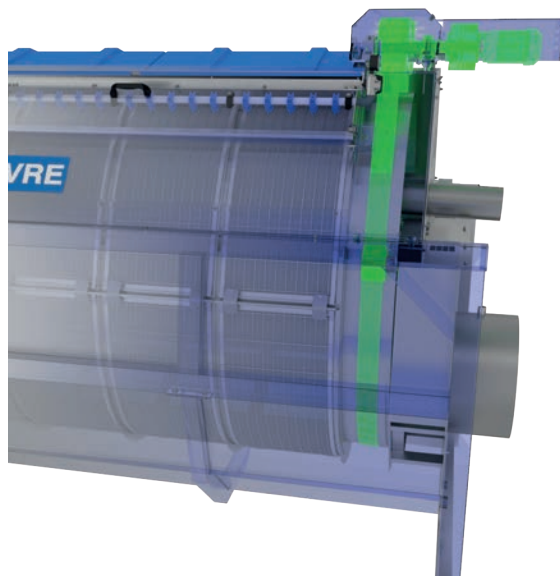

BDS simple, reliable and robust system.

Rotoclean 160 drum filters benefit from the BDS system (Belt Drive & Support system). The motor, ideally placed on top of the drum filter, drives and supports the drum with one or more belts.

In 20 years of experience, this system has shown all its advantages:

- Soft start by nature (does not require a soft start with a frequency converter)
- Reliability over time (more than 5 years without maintenance)
- Transmission does not break if the drum jams (for example: if an object enters the drum)

Rinsing ramp with optimized water consumption and pressure.

The pressure of the nozzles has been optimized in order to obtain a perfect rinsing of the fabrics without damaging them.

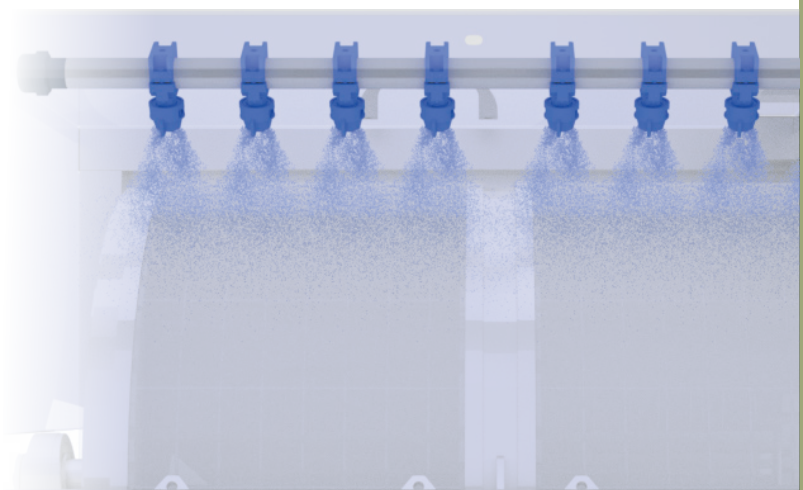

160
Rotoclean

www.favregroup.com

Pictures and technical data are not contractual. FAIVRE Sasu can bring to its equipments any modifications required, at any time.

Our Rotoclean 160 drum filters are compatible with :

- Smart filter technology (page 10)
- New Spiderplate® (page 12)

Smart
filter



SPIDERPLATE

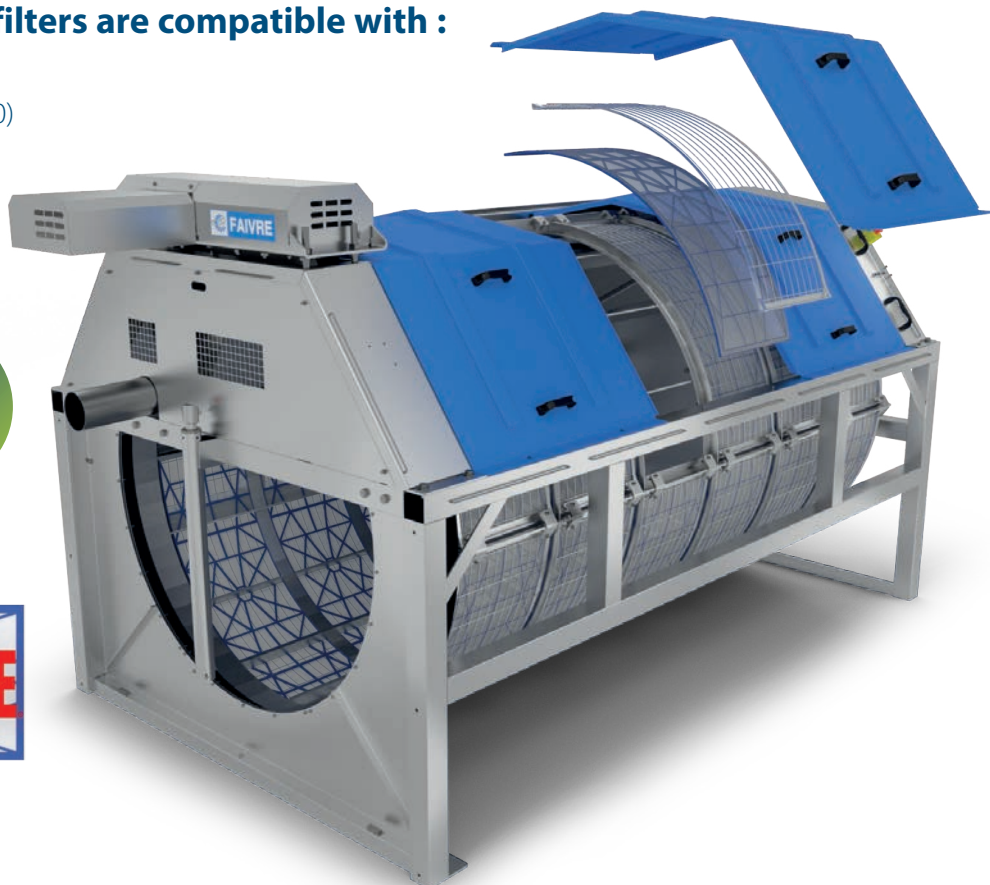

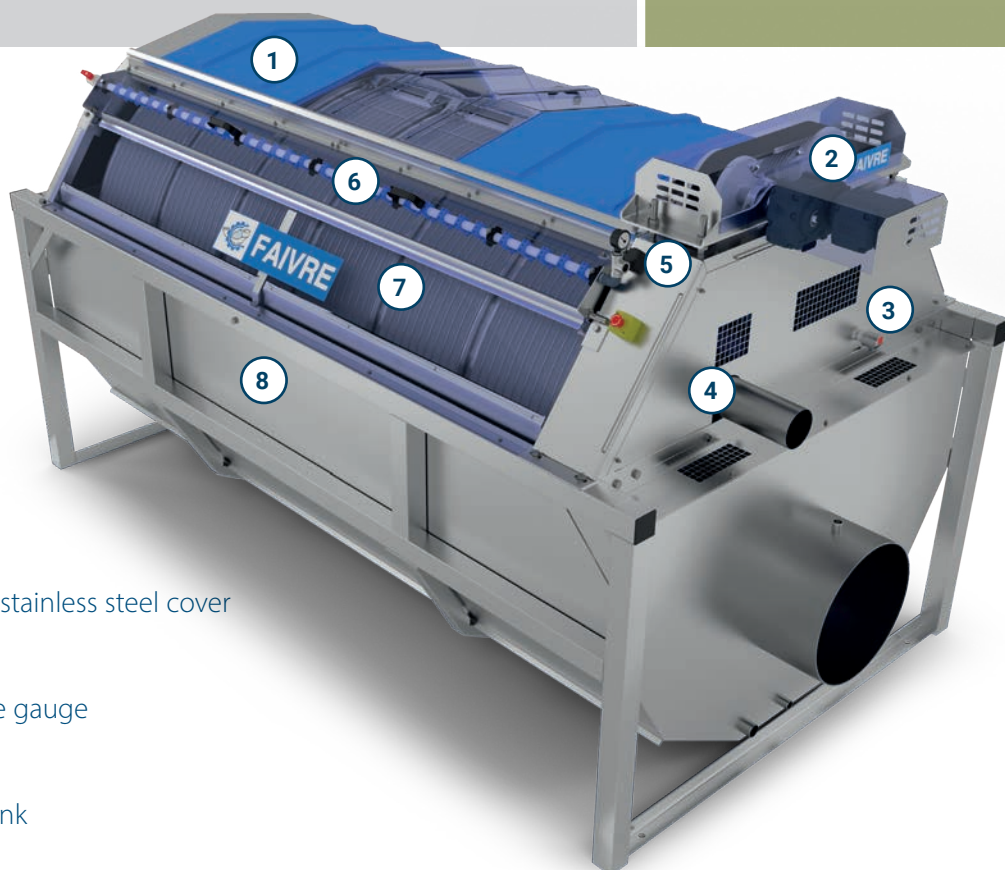

Specifications

Model	Inlet -outlet standard	Motor power	Filter surface	Number of plates	Sludge outlet diameter	Number of Spray nozzles
12 - 160	Ø 500 mm (150l/s max.)	550 W	5,16 m ²	12	Ø 125 mm	15
16 - 160			6,88 m ²	16		20
20 - 160	Ø 630 mm (200l/s max.)		8,6 m ²	20		25
24 - 160			10,32 m ²	24		30
28 - 160			12,04 m ²	28		35
32 - 160	Ø 700 mm (318l/s max.)		13,76 m ²	32		40

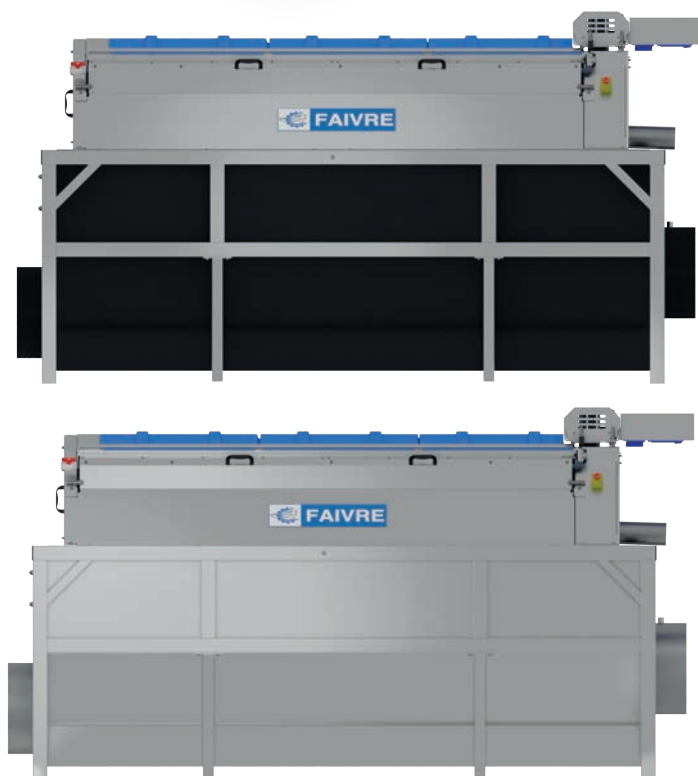
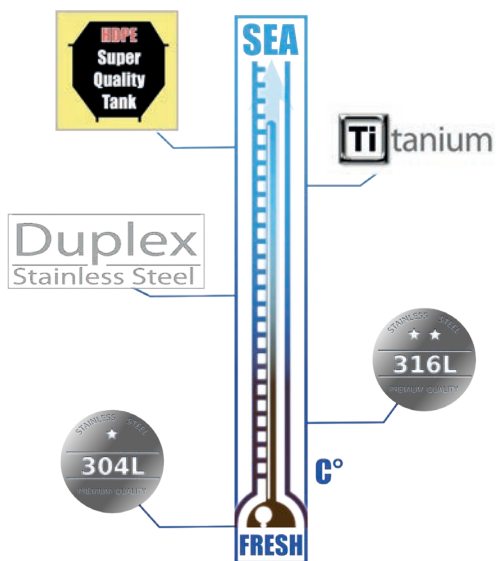

- 1 - Removable ABS covers
- 2 - Drum drive motor under stainless steel cover
- 3 - Level probe
- 4 - Sludge outlet
- 5 - Rinsing manifold pressure gauge
- 6 - Rinsing ramp
- 7 - Stainless steel drum
- 8 - Stainless steel or HDPE tank



High quality stainless steel construction.

- Exclusive use of high quality stainless steel made in northern Europe (Norway, Finland, Sweden)
- Stainless steel AISI 304L (4301) for fresh water as standard
 - Stainless steel AISI 316L (4404) for sea water as standard
 - Stainless steel DUPLEX (2205), HDPE and Titanium for hot sea water.

The CCPUs of the material constituting your filter order can be supplied to you on request.

www.faivregroup.com

Pictures and technical data are not contractual. FAIVRE Sasu can bring to its equipments any modifications required, at any time.

Frame



	12-160		16-160		20-160		24-160		28-160		32-160	
Net weight	704 kg 1552 lbs		800 kg 1764 lbs		1030 kg 2271 lbs		1050 kg 2315 lbs		1143 kg 2520 lbs		1265 kg 2789 lbs	
Unit	cm	in	cm	in	cm	in	cm	in	cm	in	cm	in
Width	190	75	190	75	190	75	190	75	190	75	190	75
Height	193	76	193	76	193	76	193	76	193	76	193	76
Length (A)	175	69	219	86	263	103	307	121	351	138	395	155
Length (B)	216	85	260	102	304	120	348	137	392	154	436	171

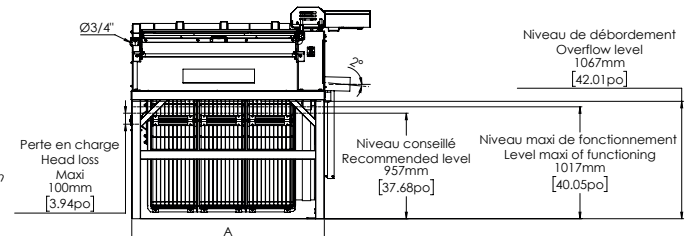
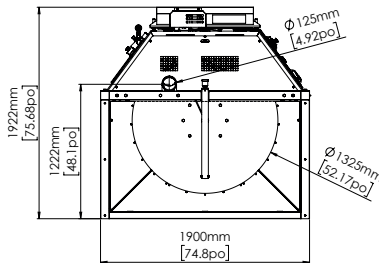
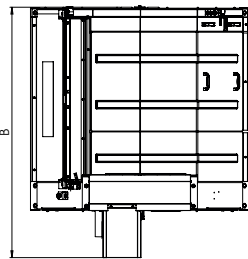

Input by pipe



	12-160		16-160		20-160		24-160		28-160		32-160	
Net weight	767 kg 1691 lbs		865 kg 1907 lbs		1092 kg 2407 lbs		1132 kg 2496 lbs		1232 kg 2716 lbs		1331 kg 2934 lbs	
Unit	cm	in	cm	in	cm	in	cm	in	cm	in	cm	in
Width	190	75	190	75	190	75	190	75	190	75	190	75
Height	193	76	193	76	193	76	193	76	193	76	193	76
Length (A)	190	75	234	92	278	109	322	126	366	144	410	161
Length (B)	216	85	260	102	304	119	348	137	392	154	436	171

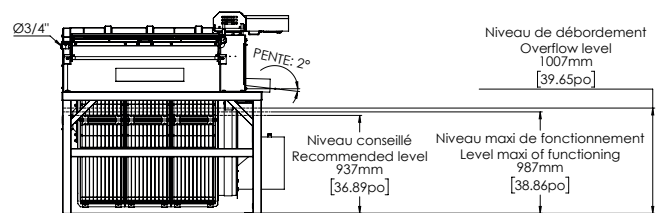
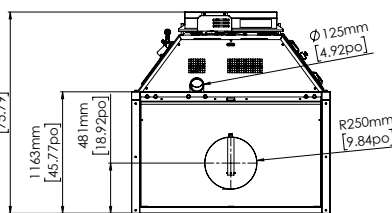
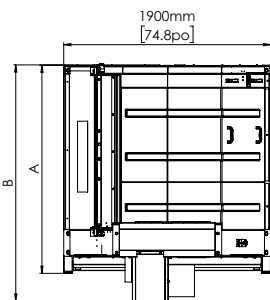

Drum filter 160 serie

Stainless steel tank



	12-160		16-160		20-160		24-160		28-160		32-160	
Net weight	952 kg 2099 lbs		1108 kg 2443 lbs		1346 kg 2967 lbs		1411 kg 3111 lbs		1535 kg 3384 lbs		1659 kg 3657 lbs	
Net weight full tank	4210 kg 9 281 lbs		5150 kg 11 353 lbs		6000 kg 13 228 lbs		6850 kg 15 102 lbs		7700 kg 16 976 lbs		8550 kg 18 850 lbs	
Unit	cm	in	cm	in	cm	in	cm	in	cm	in	cm	in
Width	190	75	190	75	190	75	190	75	190	75	190	75
Height	206	81	206	81	206	81	206	81	206	81	206	81
Length (A)	212	83	256	100	300	118	344	135	388	153	432	170
Length (B)	247	97	291	114	335	132	379	149	423	166	467	184

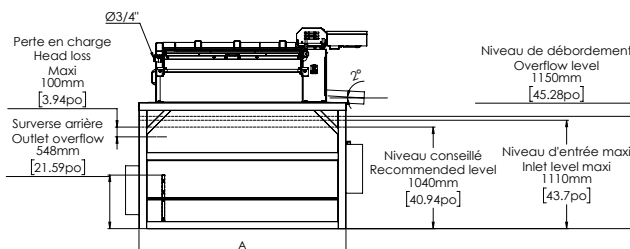
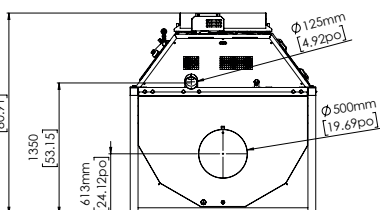
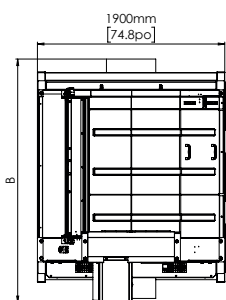

HDPE tank



	12-160		16-160		20-160		24-160		28-160		32-160	
Net weight	849 kg 1872 lbs		972 kg 2143 lbs		1197 kg 2639 lbs		1254 kg 2765 lbs		1363 kg 3005 lbs		1480 kg 3263 lbs	
Net weight full tank	4210 kg 9281 lbs		5150 kg 11353 lbs		6000 kg 13228 lbs		6850 kg 15102 lbs		7700 kg 16976 lbs		8550 kg 18850 lbs	
Unit	cm	in	cm	in	cm	in	cm	in	cm	in	cm	in
Width	193	76	193	76	193	76	193	76	193	76	193	76
Height	205	81	205	81	205	81	205	81	205	81	205	81
Length (A)	209	82	253	99	297	117	341	134	385	151	429	169
Length (B)	247	97	291	114	335	131	379	149	423	166	467	184

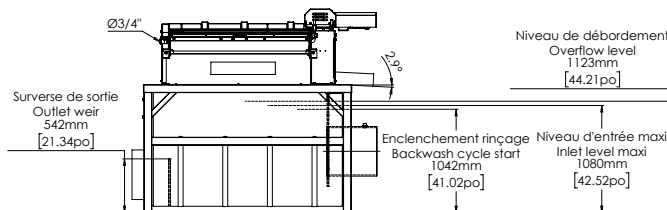
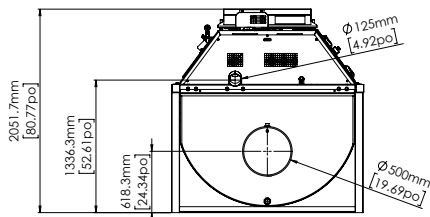
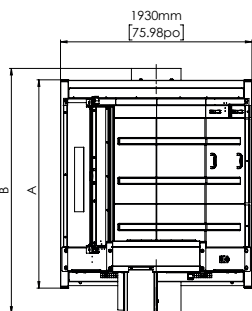

160
Rotoclean

Options



Rinsing pump.

Vertical pump used for cleaning filter meshes. This pump is connected to the filter unclogging ramp. Its pressure is calculated so as to be adapted to the mesh of the filter.

The pump is delivered with all the accessories for connection to the drum filter.

Control box with polyester box.

The control box is optional. It allows optimum control and safety for all our drum filters.

The large IP65 polyester box is more suitable for model 120, 160 or 200 filters.

For the safety of people, the box includes:

- 1 lockable disconnecter.
- 2 emergency stops including 1 on the front of the cabinet, 1 other emergency stop is positioned on the drum filter.
- 1 fast-tripping current detector is also integrated in the box. This current detector allows the filter to stop instantly in the event that the filter suddenly becomes blocked. (which can happen when a foreign body that is too large enters the filter with the water)

For the safety of the equipment, the box includes:

- 1 circuit breaker unit for the power supply to the cabinet.
- 2 thermal circuit breakers to protect the motor of the drum filter and the motor of the rinsing pump.

The control box is delivered with:

- 5m cable for the power supply.
- 10m cable with M23 connector to easily connect the drum motor, the flushing pump, the emergency stop and the hood safety switch.
- 10m of cable with an M12 connector to easily connect the water level radar.

Ref. :

- FTC021-B24

Power supply 3 x 200 - 230 - 400 - 440 - 480 - 575 V 50Hz/60Hz

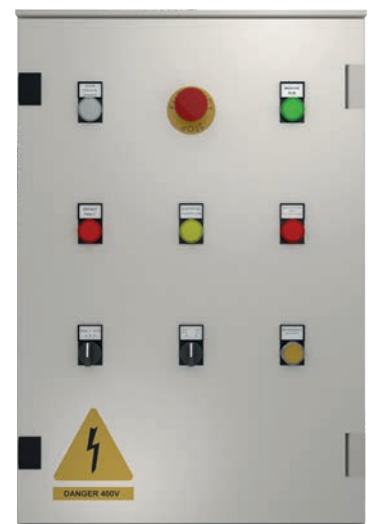
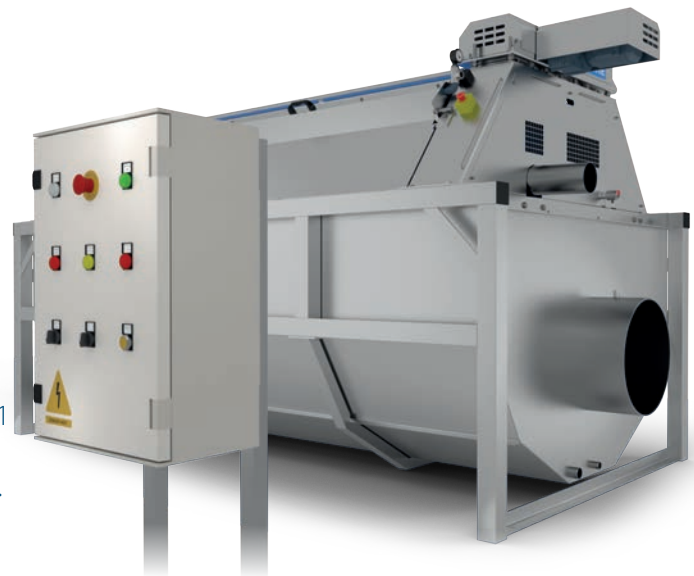

Level probe and (or) Timer

A level probe and a timer are 2 possible options in order to control the operation of the drum filter.

The level probe is a high-performance radar which only takes into account the level of the liquid and which is not disturbed by foam on the surface of the filtered liquid.

The timer allows the drum to be started and stopped by simple programming on the component inside the cabinet using a screwdriver.

These two options are available separately or together on the boxes, please specify this when ordering.



RADAR



TIMER

Ref. :

- **FTDSN4** Level radar **LR2050**

- **FTDT01** Cabinet timer **FTC001-EAS**

Installation examples

FT160 Frame

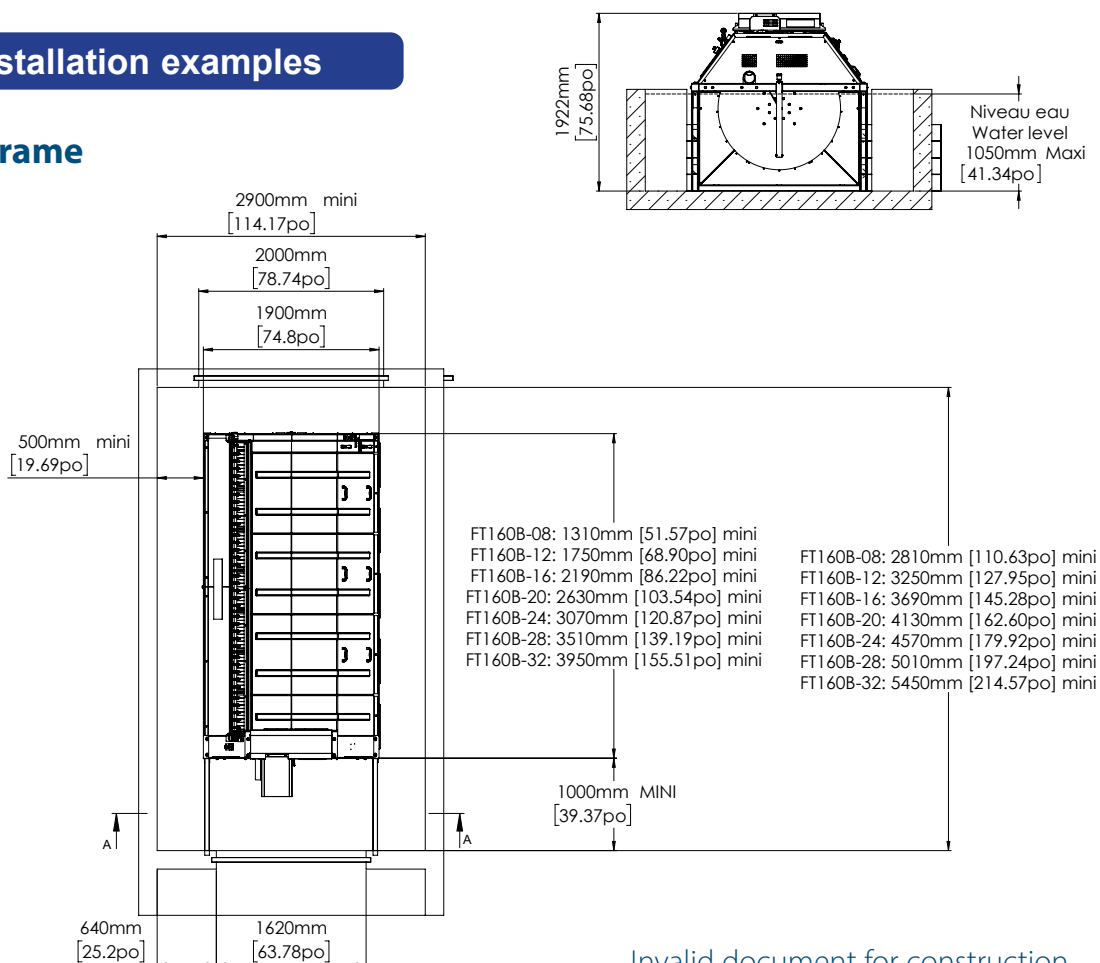

Invalid document for construction

200 DrumFilter

Serie

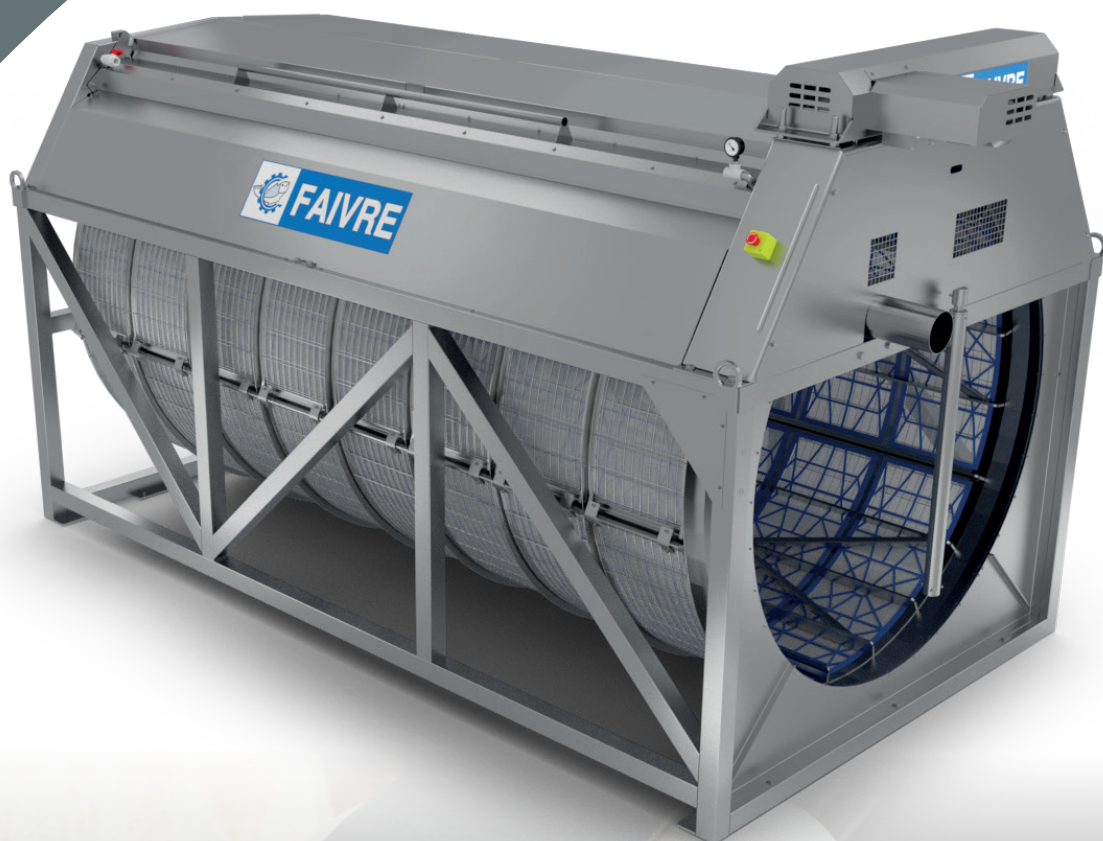

www.favregroup.com



Drum filter 200 serie

Model



Drum filter 200

Flow rate up to 900 l/s (3240 m³/h) at 100 µ.

With a 200cm diameter drum, the Rotoclean 200 is the largest filter in the Rotoclean drum filter range.

The 200 series filters are specially designed for the filtration of effluents leaving large fish farms, they are also ideal for large closed circuits.

Its 200 cm diameter drum rotates at 3 revolutions/min.

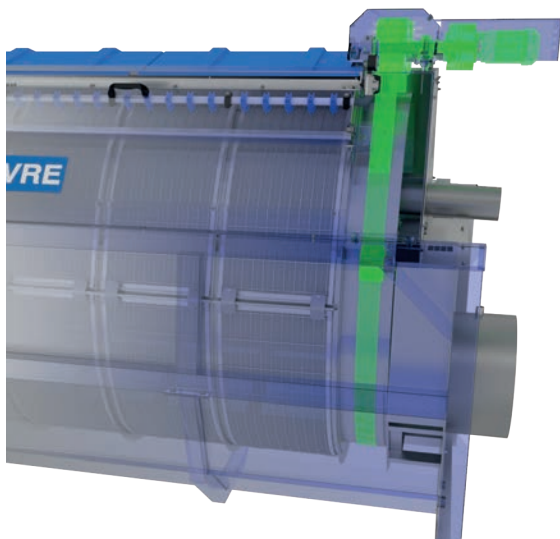

BDS simple, reliable and robust system.

Rotoclean 200 drum filters benefit from the BDS system (Belt Drive & Support system). The motor, ideally placed on top of the drum filter, drives and supports the drum with one or more belts.

In 20 years of experience, this system has shown all its advantages:

- Soft start by nature (does not require a soft start with a frequency converter)
- Reliability over time (more than 5 years without maintenance)
- Transmission does not break if the drum jams (for example: if an object enters the drum)

Rinsing ramp with optimized water consumption and pressure.

The pressure of the nozzles has been optimized in order to obtain a perfect rinsing of the fabrics without damaging them.

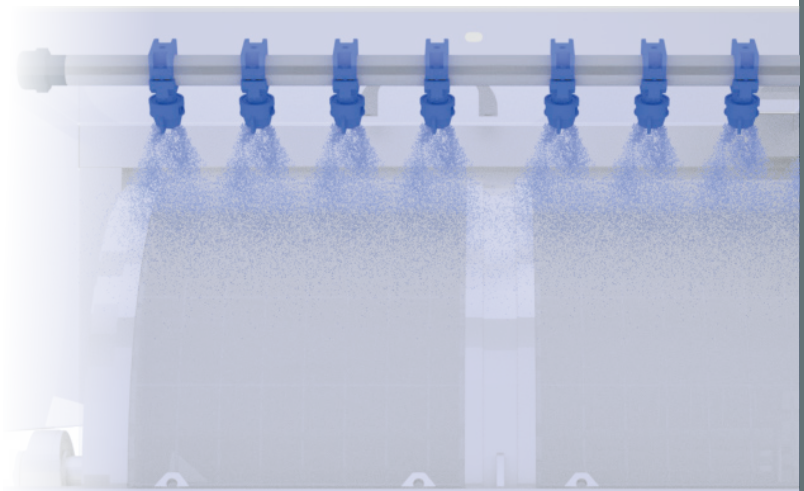

200
Rotoclean

www.faivregroup.com

Pictures and technical data are not contractual. FAIVRE Sasu can bring to its equipments any modifications required, at any time.

Our Rotoclean 200 drum filters are compatible with :

- Smart filter technology (page 10)
- New Spiderplate® (page 12)

**Smart
filter**

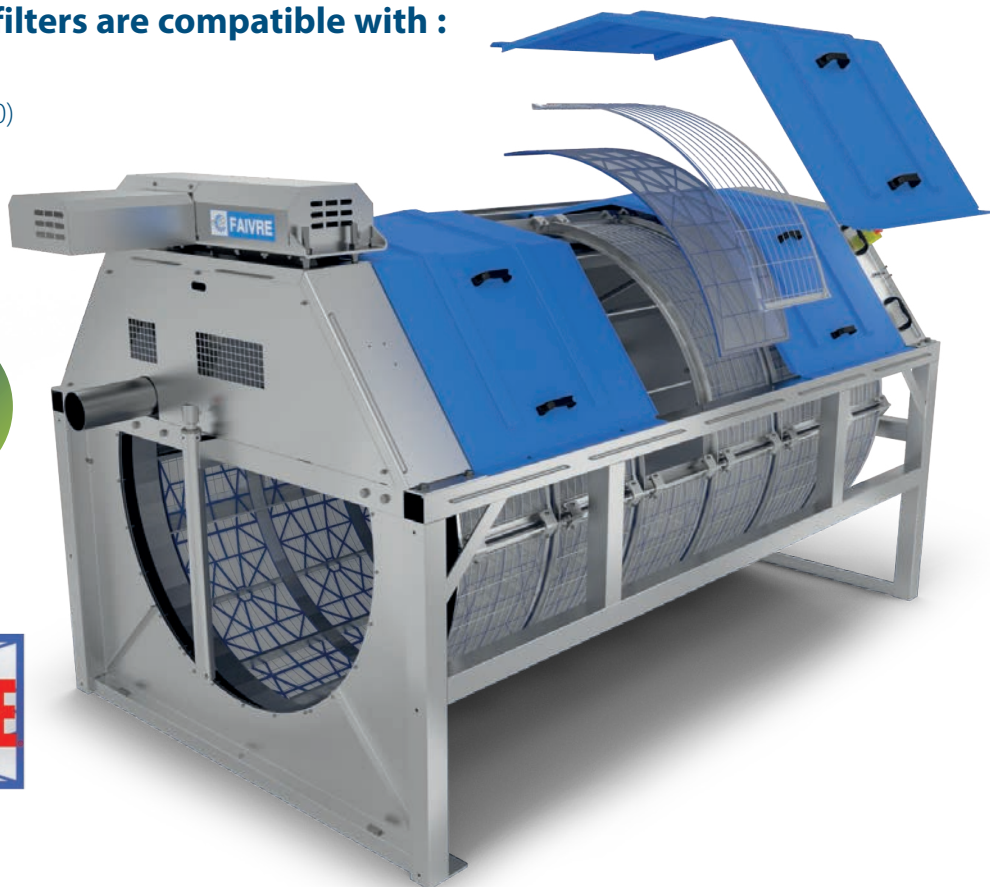

SPIDERPLATE

Specifications

Model	Inlet -outlet standard	Motor power	Filter surface	Number of plates	Sludge outlet diameter	Number of Spray nozzles
20 - 200	Drum filter on frame only	550 W	8,80 m ²	20	Ø 140 mm	20
25 - 200			11 m ²	25		25
30 - 200			13,20 m ²	30		30
35 - 200			15,40 m ²	35		35
40 - 200			17,60 m ²	40		40

- 1 - Removable stainless steel covers
- 2 - Rinsing ramp
- 3 - Drive motor under stainless steel cover
- 4 - Level probe
- 5 - Sludge outlet
- 6 - Stainless steel frame with lifting rings
- 7 - Rinsing manifold pressure gauge
- 8 - Stainless steel drum

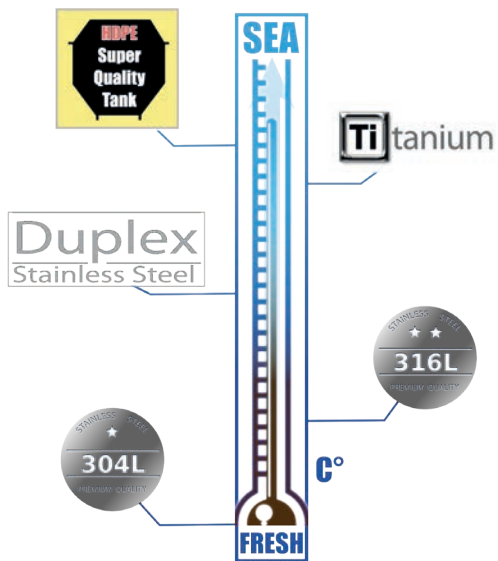
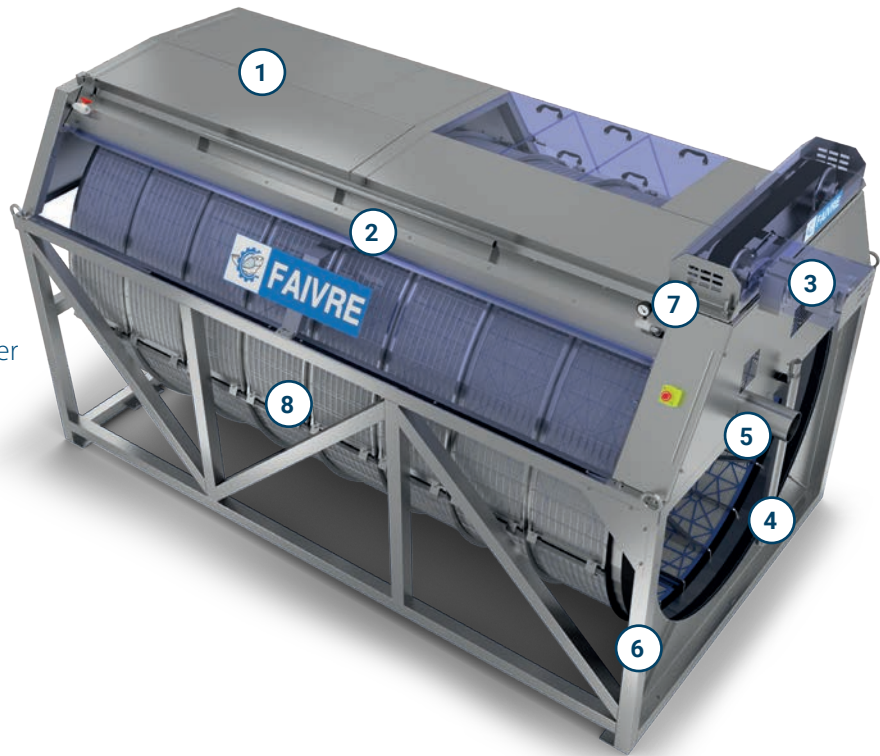

High quality stainless steel construction.

Exclusive use of high quality stainless steel made in northern Europe (Norway, Finland, Sweden)

- Stainless steel AISI 304L (4301) for fresh water as standard
- Stainless steel AISI 316L (4404) for sea water as standard
- Stainless steel DUPLEX (2205), HDPE and Titanium for hot sea water.

The CCPUs of the material constituting your filter order can be supplied to you on request.

www.faivregroup.com

Pictures and technical data are not contractual. FAIVRE Sasu can bring to its equipments any modifications required, at any time.

• Frame

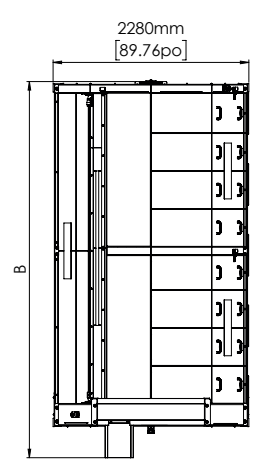
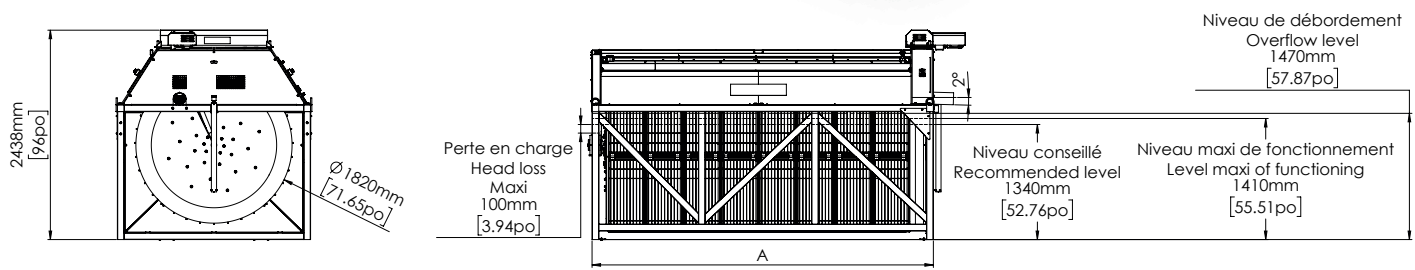

	20-200		25-200		30-200		35-200		40-200	
Net weight	1523 kg 3358 lbs		1697 kg 3741 lbs		1871 kg 4125 lbs		2045 kg 4508 lbs		2220 kg 4894 lbs	
Unit	cm	in	cm	in	cm	in	cm	in	cm	in
Width	228	90	228	90	228	90	228	90	228	90
Height	246	96	246	96	246	96	246	96	246	96
Length (A)	222	87	266	105	310	122	354	139	398	156
Length (B)	262	103	306	120	350	138	394	155	438	172

Options



Control box with polyester box.

The control box is optional. It allows optimum control and safety for all our drum filters.

The large IP65 polyester box is more suitable for model 120, 160 or 200 filters.

For the safety of people, the box includes:

- 1 lockable disconnecter.
- 2 emergency stops including 1 on the front of the cabinet, 1 other emergency stop is positioned on the drum filter.
- 1 fast-tripping current detector is also integrated in the box. This current detector allows the filter to stop instantly in the event that the filter suddenly becomes blocked. (which can happen when a foreign body that is too large enters the filter with the water)

For the safety of the equipment, the box includes:

- 1 circuit breaker unit for the power supply to the cabinet.
- 2 thermal circuit breakers to protect the motor of the drum filter and the motor of the rinsing pump.

The control box is delivered with:

- 5m cable for the power supply.
- 10m cable with M23 connector to easily connect the drum motor, the flushing pump, the emergency stop and the hood safety switch.
- 10 m of cable with an M12 connector to easily connect the water level radar.

Ref. :

- FTC021-B24

Power supply 3 x 200 - 230 - 400 - 440 - 480 - 575 V
50Hz/60Hz

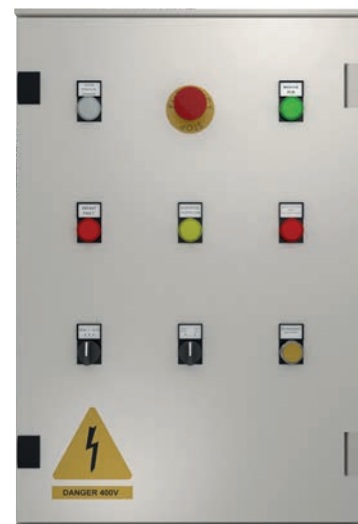

Level probe and (or) Timer

A level probe and a timer are 2 possible options in order to control the operation of the drum filter.

The level probe is a high-performance radar which only takes into account the level of the liquid and which is not disturbed by foam on the surface of the filtered liquid.

The timer allows the drum to be started and stopped by simple programming on the component inside the cabinet using a screwdriver.

These two options are available separately or together on the boxes, please specify this when ordering.

Ref. :

- **FTDSN4** Level radar **LR2050**
- **FTDT01** Cabinet timer **FTC001-EAS**



RADAR



TIMER

Installation examples

1 FT200 Frame

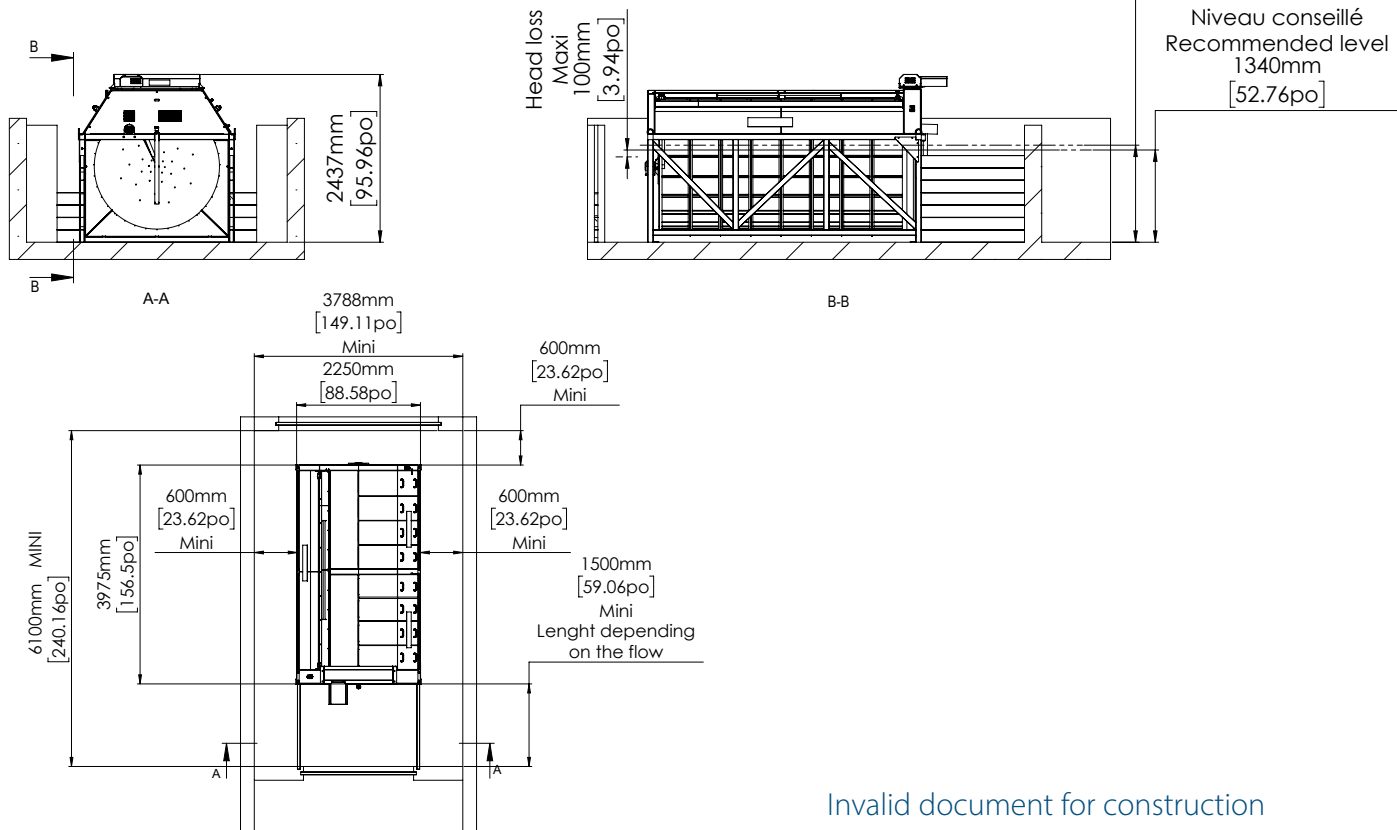

3 FT200 Frame

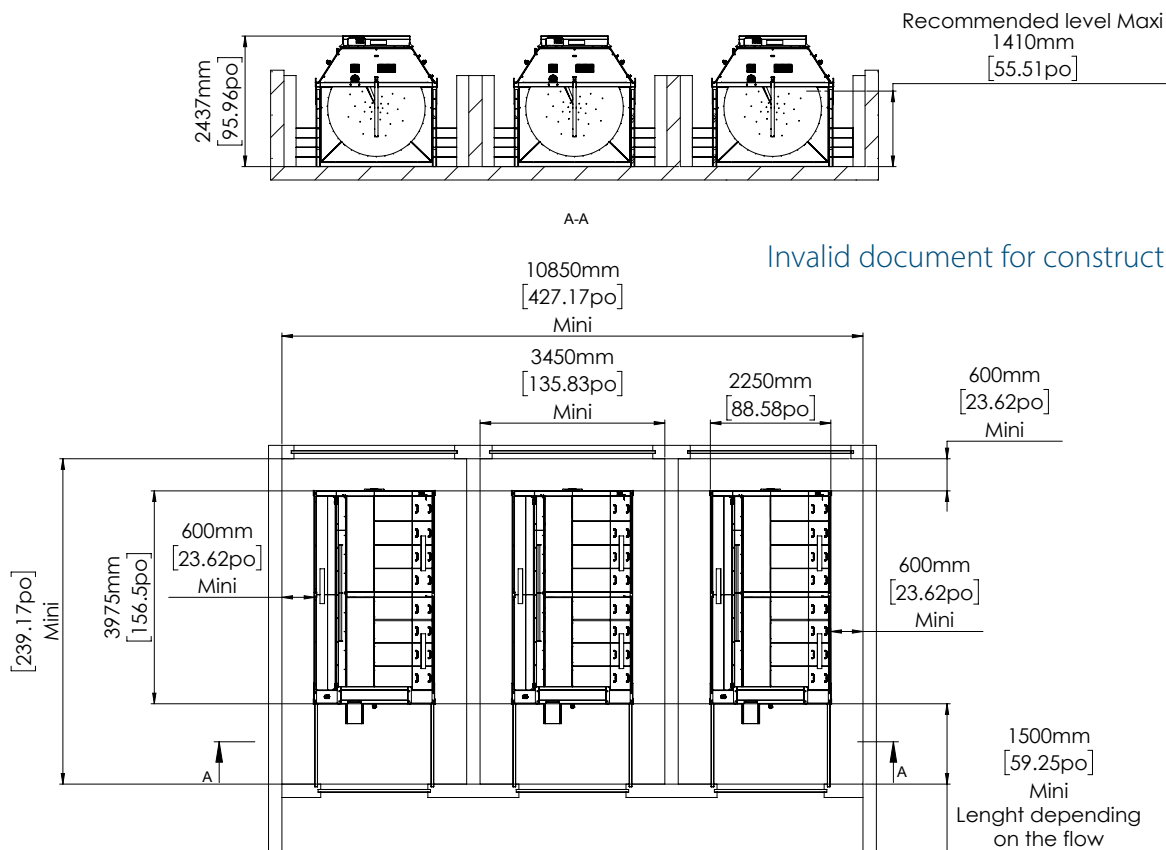

200
Rotoclean

Aerator

- Flobull..... 69
- Aquasub..... 72



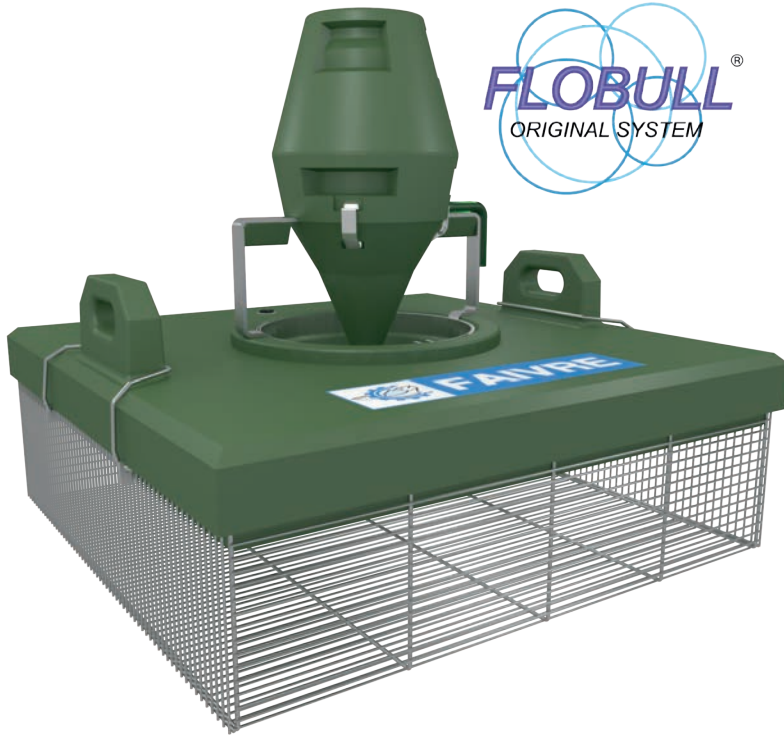

FLOBULL is a floating surface aerator

Well known to aquaculture professionals, Flobull has been the benchmark for over 50 years.

Very stable placed on its large polyethylene float, it always remains in place. Simple in design, its maintenance is very easy. Its stainless steel grid and arms are insensitive to corrosion. Despite their low power consumption of 180 W to 1500 W, the Flobulls have a water circulation rate of 75 to 380 m³/h. The significant oxygen supply in the water is 1,2 kg of O₂/h for a Flobull of 0,75 kW

THE OXYGENATION OF THE WATER ENSURES YOUR FISH GROWTH IN THE BEST CONDITIONS.

Benefits of oxygenation:

- Increase in tank load without modifying the rearing surface.
- Faster growth of fish.
- Improved water quality.

Its process: the FLOBULL aerator projects a spray of highly emulsified water into the air, which then benefits from maximum contact with the atmosphere. Thus the oxygen in the air is transferred to the water.

Note that the transfer of oxygen, while taking place, restores the gas balance of the water (elimination of harmful gases). Another important advantage, this process does not raise the temperature of the water because the contact with the sometimes warmer ambient air, is compensated by cooling caused by evaporation.

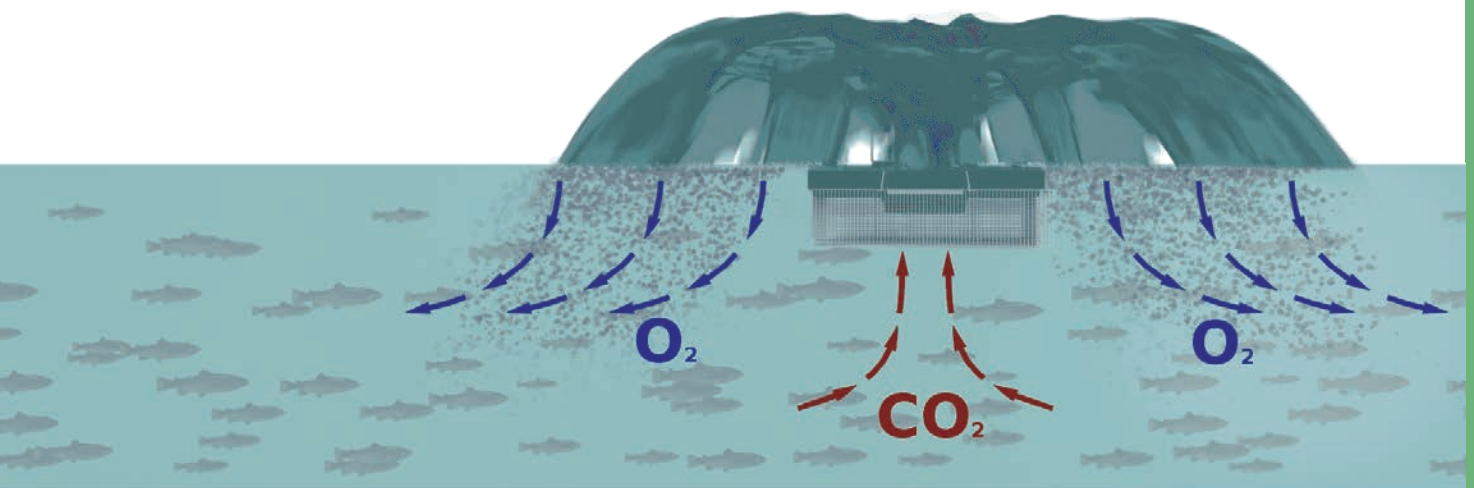

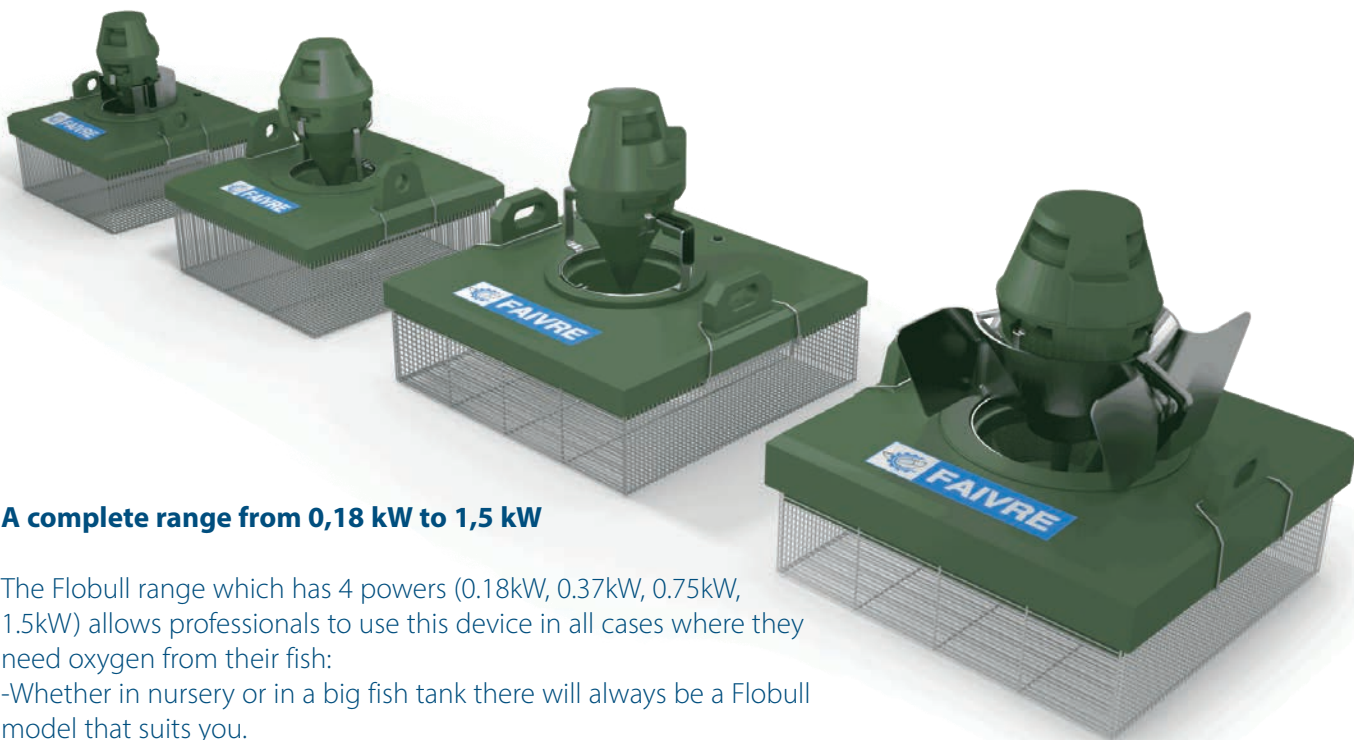

A complete range from 0,18 kW to 1,5 kW

The Flobull range which has 4 powers (0.18kW, 0.37kW, 0.75kW, 1.5kW) allows professionals to use this device in all cases where they need oxygen from their fish:
-Whether in nursery or in a big fish tank there will always be a Flobull model that suits you.

A device designed for professionals.

50 years of experience in the manufacture of Flobulls make the difference. The maintenance of our devices is simple.

A large stainless steel grid located under the entire float which can be easily removed by hand using stainless steel clips.

An engine block that can be changed just as easily.

Device that does not fear corrosion because entirely built in stainless steel polyethylene.



Specifications

- 1 - IP 56 motor
- 2 - Engine cover
- 3 - Projection cone
- 4 - Injected acetate resin propeller
- 5 - Rotomolded polyethylene float
- 6 - Large stainless steel grid spacing 10mm

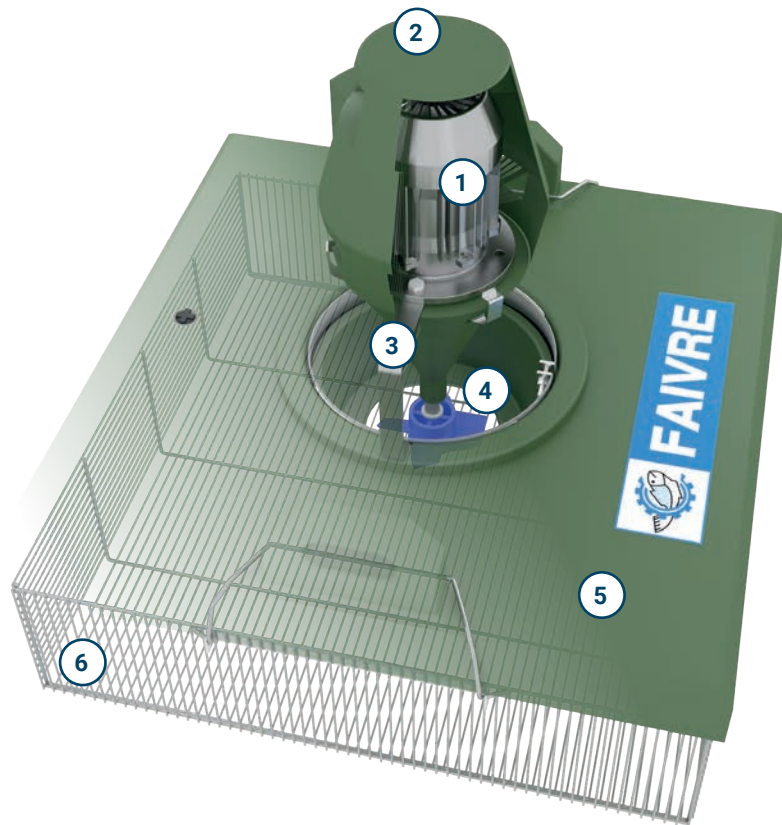

Flobull	0,25 HP	0,5 HP	1 HP	2 HP
Motor power (kw)	0,18	0,37	0,75	1,5
Absorbed power (kw)	0,32	0,57	1,05	1,95
Flow of treated water (m ³ / h)	75	135	225	380
Oxygen production (O ₂ / h)	0,42	0,64	1,12	2,20
Spray height (m)	0,65	0,80	1,10	1,40
Spray diameter (m)	2,5	3	3,5	4,5
Dimensions (m)	0,6x0,6	0,7x0,7	0,9x0,9	0,9x0,9
Height (m)	0,55	0,68	0,80	0,80
Weight (kg)	16	28	39	42
Réf. *220 - 230 V 1 phase 50 Hz	APF0021	APF0051	APF0101	APF0201
380 - 415 V 3 phases 50 Hz	APF0023	APF0053	APF0103	APF0203

Options

Power cable length

The aerator comes with a 20 meter cable.
Optionally you can obtain lengths of up to 80 meters depending on the power of the requested motor

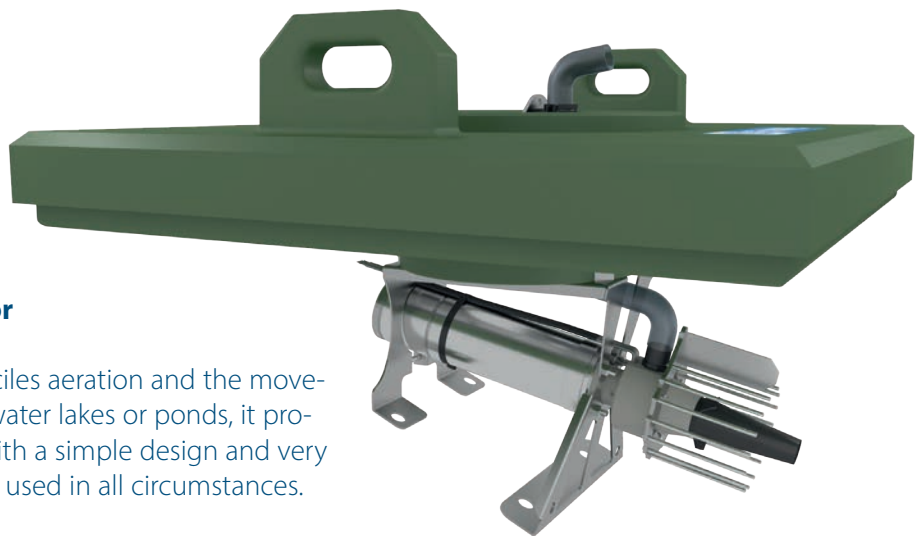

Aquasub is a floating surface aerator

AQUASUB is a hydro-ejector that reconciles aeration and the movement of masses of water. Used in freshwater lakes or ponds, it provides the oxygen essential to fish life. With a simple design and very robust construction, our devices can be used in all circumstances.

The Aquasub can be used in many cases:

- For aeration and destratification of lakes, ponds
- For the desaturation of water supersaturated with gas, etc ...

A complete range of Aquasub with 5 powers ranging from 0.37kW to 4kW is available.

High performance.

A special pressure reducing turbine rotating at 3000 rpm is attached to the end of the motor shaft. The air coming through the guide tube is drawn into the center of the propeller by the VENTURI effect. The air mixed with the water is diffused in micro-bubbles in the water current created and directed towards the bottom. The amount of oxygen transferred is optimum because the micro-bubbles have a very long residence time in the volume of water pushed.

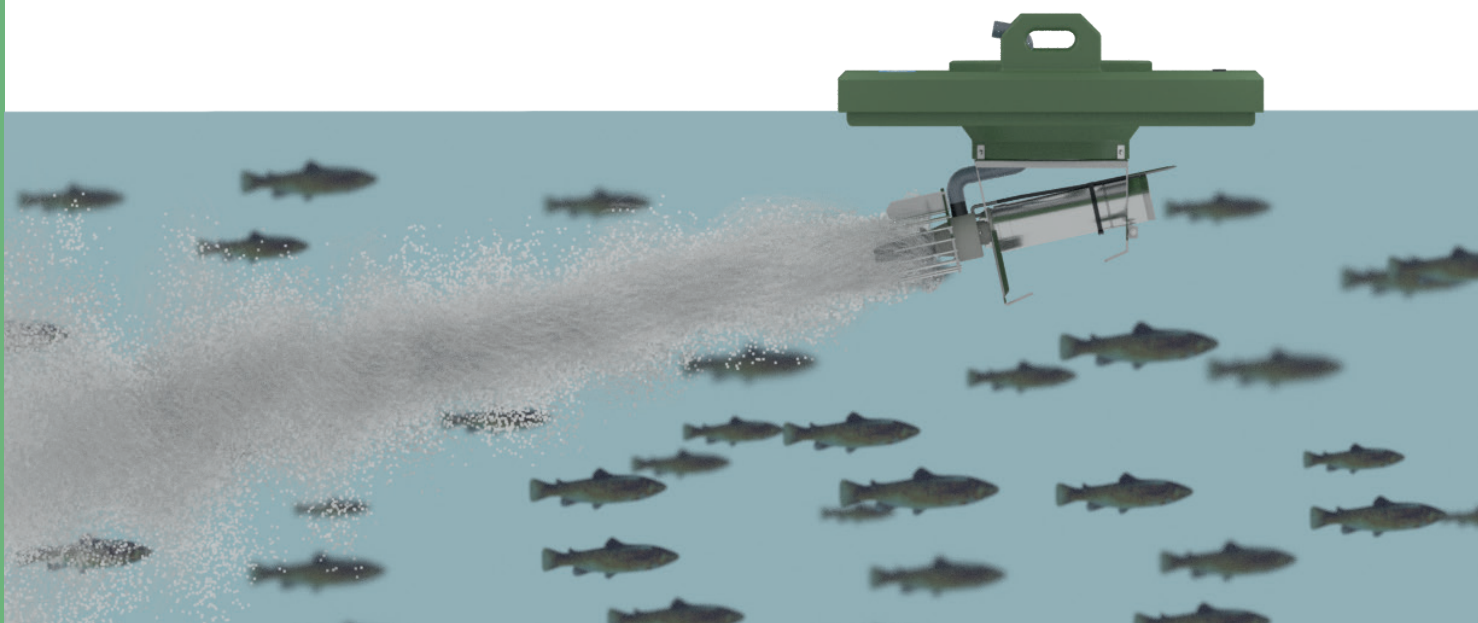

Practical and economical advantage

- ADVANTAGES: A stream of water rich in oxygen
- Reduces fish mortality due to lack of oxygen
- Prevention of the development of phytoplankton (cyanophyceae) as well as weeds.
- The biodegradation (by aerobic bacteria) of organic pollutants kept in suspension.
- An increase in the density of the fish, its growth rate, its good sanitary condition.
- Circulation and mixing of water masses
- Destratification of water bodies, lakes, ponds ...
- In winter, can be used to keep part of the body of water open.
- Compact, portable unit
- Little noisy
- Very simple and inexpensive installation
- Discreet and floating unit (no level adjustment)
- No maintenance (no lubrication)
- Self-cleaning strainer

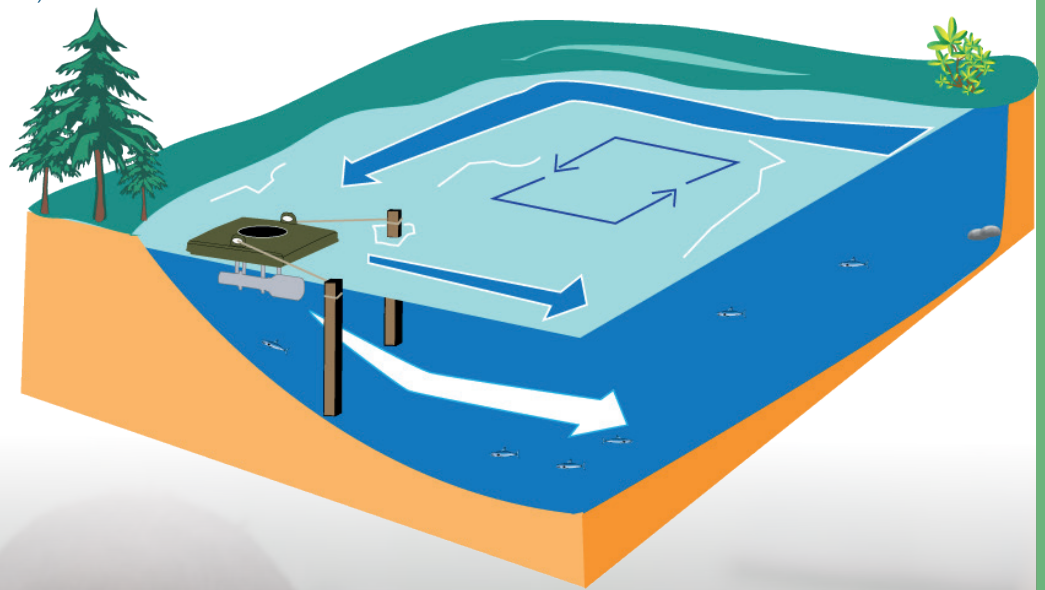

Specifications

- 1 - Air suction by venturi effect with silencer (option)
- 2 - Rotomolded polyethylene float
- 3 - IP67 stainless steel submersible motor (speed 3000rpm)
- 4 - Stainless steel strainer
- 5 - 3-blade propeller in composite materials
- 6 - Stainless steel motor support frame

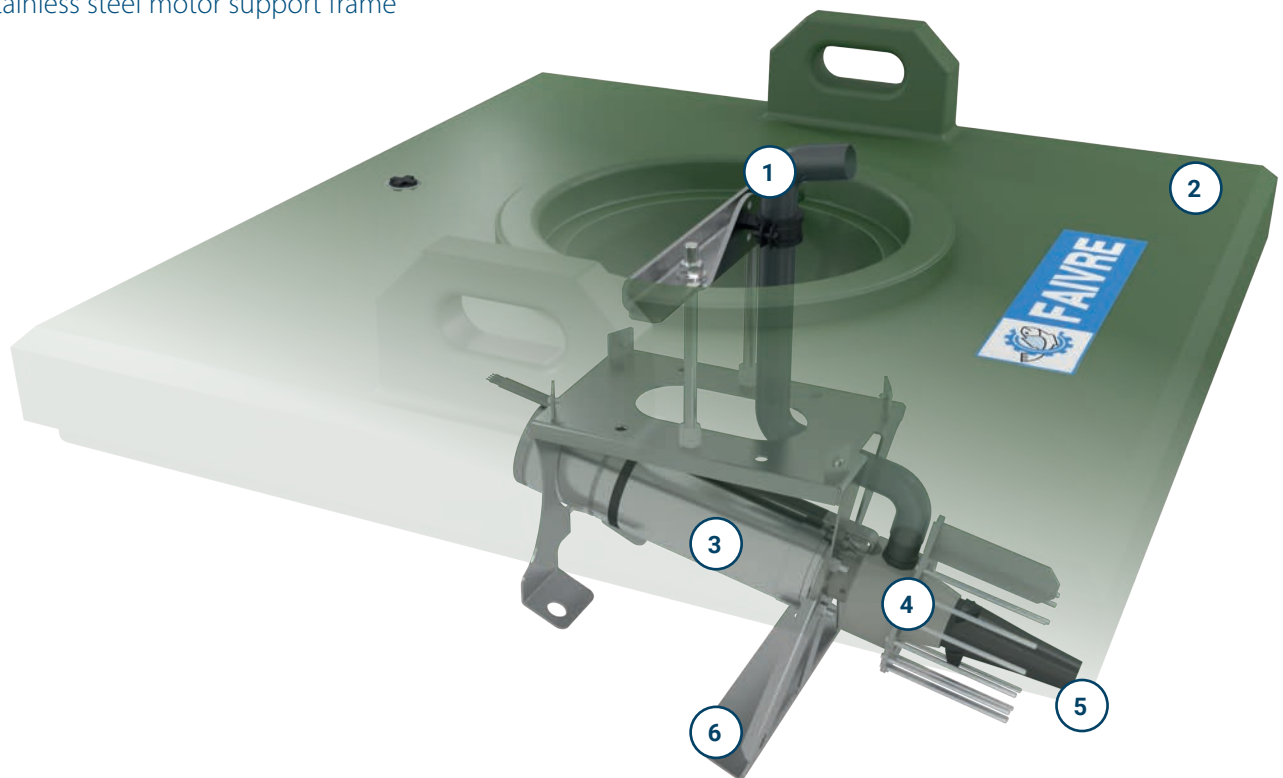

AQUASUB	0.5Cv	1Cv	2Cv	3Cv
Puiss. moteur (kW)	0,37	0,75	1,5	2,2
Débit d'eau traité (m3/hr)	200	300	550	750
Production d'oxygène (kg O ₂ /hr)	0,5	0,8	1,7	2,6
Dimensions l x L x H (m)	0.5 x 0.5 x 0.6	0.9 x 0.9 x 0.7	0.9 x 0.9 x 0.7	0.9 x 0.9 x 0.7
Poids (kg)	25	36	41	47
Réf. *220 - 230V 1 phase 50 Hz	APH 0051	APH 0101	APH 0201	APH 0301
380 - 415 V 3 phases 50 Hz	APH 0053	APH 0103	APH 0203	APH 0303

Options

Power cable length

The aerator comes with a 20 meter cable.

Optionally you can obtain lengths of up to 80 meters depending on the power of the requested motor



Live stock catalog



FAIVRE Company is not only specialized in the conception and the production of drum filters, leaf screeners and aerators as well. Indeed, FAIVRE also designs machines for of machines for fish farming (fish graders, fish counters, fish pumps). Our machines are well known for their reliability and quality since 1958.

New catalog Live Stock management 2023. With this new catalog we are glad to introduce our new Fish pump Pescamotion 50 (10 in) and our new fish grader Helios 300.

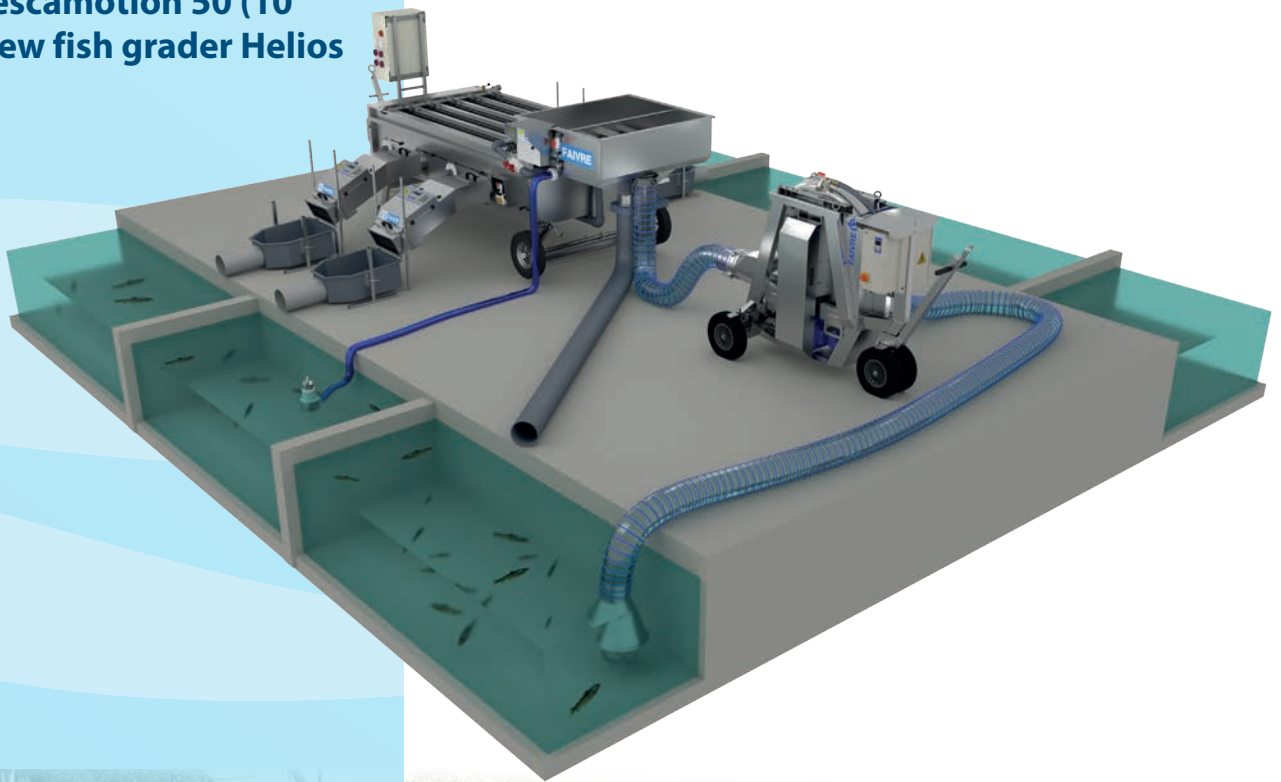

www.favregroup.com

Live stock catalog



• Fish pump



• Fish grader



• Fish counter

• Fish pumps



Find all these equipment in our Live Stock management catalog.





FAIVRE

**DESIGNER & MANUFACTURER OF
FISH FARMING EQUIPMENT**
www.faivregroup.com